

„ WOLLEN WIR HEUTE ZUSAMMEN BLAUMACHEN?“

FARBENFROHE KÜCHEN.

Die neuesten Küchentrends laden dazu ein, den Rest der Welt fast zu vergessen. Finden Sie die richtige Küche und erleben Sie jeden Tag in der Woche ein entspanntes Sonntagsgefühl.

prisma[®]
meine Küche!



Salerno
Jersey

6



Nebraska
New Mexico

26



Iowa

52



Salerno
McAllen

10



McAllen

32



Kansas

54



New Mexico

14



McAllen

46



Kansas
Georgia

60



Nebraska
Louisiana

20



Georgia
McAllen

50



Iowa

64



Georgia

70



**Louisiana
Salerno**

88



**McAllen
New Mexico**

104



Louisiana

76



Pennsylvania

90



Nischenmotive
Recess motifs
Nismotieven
Motifs crédence

110



Louisiana

78



Louisiana

98



Fronten | Front Panels
Fronten | Façades

114



**Nebraska
Louisiana**

84



**Kentucky
Georgia**

100



Griffe | Handles
Grepes | Poignées

125

FÜR GEMEINSAME MOMENTE





*FOR SHARED MOMENTS
VOOR GEZAMENLIJKE MOMENTEN
DU BONHEUR À PARTAGER*



SALERNO JERSEY

DARK GROOVE

SCHWARZ SEIDENMATT



SINN FÜR DESIGN

*DESIGN SENSE
GEVOEL VOOR DESIGN
LE SENS DU DESIGN*

Eleganz darf funktional sein! Unsere widerstandsfähige Schichtstoff-Front Jersey zeigt sich robust und in seidigem Schwarz. Praktischer Bonus: eine Anti-Fingerprint-Beschichtung gegen Fingerabdrücke.



Let elegance be practical too! Our hard-wearing Jersey laminate front is robust and comes in silky matt black. Practical bonus: anti-fingerprint coating to keep finger marks at bay.

Elegantie mag functioneel zijn! Ons slijtvaste laminaatfront Jersey is robuust en wordt geleverd in zwart zijdemat. Handige bonus: anti-fingerprint-coating tegen vingerafdrukken.

Élégance rime avec fonctionnalité ! Notre façade Jersey en stratifié, résistante et robuste, se distingue par son fini noir mat soyeux. Son atout pratique : un revêtement anti-traces de doigts.



Modernes Stilmittel: Die Rillenstruktur unserer Front Salerno ist angesagt. Kein Wunder, harmoniert sie doch prächtig mit Licht und kontrastierten Elementen.



Expression of modern style: the grooved structure on our Salerno front is so hip. No wonder, because it harmonises so beautifully with light and contrasting elements.

Modern stijlmiddel: de gegroefde structuur van ons front Salerno is helemaal in. Geen wonder, want het harmonieert prachtig met licht en contrasterende elementen.

Une icône du style : la structure rainurée de notre façade Salerno est au goût du jour. Rien d'étonnant puisqu'elle s'harmonise merveilleusement bien avec l'éclairage et les éléments contrastants.







SALERNO McALLEN

DARK GROOVE

SAND



TRENDSETTER MIT KLARER IDEE

Die Rille liegt im Trend: Wenn sich Linie an Linie reiht, entstehen Tiefeneffekte mit einzigartiger Wirkung. Vollendung findet die Rillenoptik in unserer hochwertigen Melaminharz-Front Salerno. Beide Dekore ermöglichen zeitgemäße Planungen zu attraktiven Konditionen - und eine Linienstruktur in der Küche, die neue Maßstäbe an Design setzt.

SALERNO

TRENDSETTER WITH A CLEAR IDEA

Grooves are all the trend: lined up in rows, they create a sense of depth with unique effect. Our high-quality melamine resin Salerno front takes the grooved look to perfection. Both decor finishes provide contemporary planning options on attractive terms - while bringing linear structure to the kitchen that sets new design standards.



SAALERNO 188
Soft Groove

SAALERNO 189
Dark Groove

TRENDSETTER MET EEN HELDER IDEE

De groef is trendy: wanneer lijn naast lijn mooi doorloopt, ontstaan diepte-effecten met een unieke impact. De gegroefde look werd bij ons hoogwaardige melamineharsfront Salerno geperfectioneerd. Beide decors maken een eigentijdse planning mogelijk tegen aantrekkelijke voorwaarden - en een lijnenspel in de keuken dat nieuwe normen stelt op het gebied van design.

DANS L'AIR DU TEMPS

Les rainures sont très tendance : alignées, elles créent un superbe effet de profondeur. Le look rainuré de notre façade Salerno mélaminée de qualité supérieure est le summum de l'élégance. Les deux décors permettent des conceptions contemporaines à des conditions intéressantes et des lignes dans la cuisine qui posent de nouveaux jalons en termes de design.

NEW MEXICO

SANDBEIGE HOCHGLANZ







BEEINDRUCKENDER BLICKFANG



*IMPRESSIVE LOOKER
INDRUKWEKKENDE
BLIKVANGER
ATTIRE TOUS LES
REGARDS*

ELEGANZ AUF GANZER LINIE

Klappenschränke mit Rauchglastüren bilden einen krönenden Abschluss. Der Spritzschutz Connect am Kochfeld greift das Design auf und verfügt über praktische Steckdosen. Genießer freuen sich über den Komfort eines Weinkühlschranks.

ELEGANCE ACROSS THE BOARD

Flap-door cabinets with smoky glass doors provide the crowning glory. The Connect splashback behind the hob picks up on the whole design and comes with practical power sockets. Connoisseurs simply love the convenience of a wine refrigerator.

ELEGANTIE OVER DE HELE LINIE

Klepkasten met deuren van rookglas vormen een kroon op het werk. De Connect-spatwand bij de kookplaat sluit aan op het design en heeft praktische stopcontacten. Kenners genieten van het gemak van een wijnkoelkast.

ÉLÉGANCE DE A À Z

Les meubles à abattants, équipés de portes en verre fumé, subliment l'aménagement. Munie de prises femelles pratiques, la plaque antiprojection Connect derrière la table de cuisson reprend le design de la cave à vin qui fera le bonheur des gourmets.

IDEEN, DIE FREUDE MACHEN

KOMFORT VOLLER IDEEN
Ob mattschwarze Nischenausstattung
oder durchdachte Innenorganisation nach
Maß - LED-Leuchten rücken die über-
zeugenden Highlights ins rechte Licht.





INGENIOUS CONVENIENCE - Whether matt black splashback or bespoke drawer interiors - LED provides the perfect lighting for stunning kitchen elements.

COMFORT VOL IDEEËN - Of het nu gaat om een matzwarte nisinrichting of een doordachte interieurorganisatie op maat - led-lampen zetten de overtuigende highlights in het juiste licht.

CONFORT PLEIN D'IDÉES - Qu'il s'agisse d'un équipement de crédence noir mat ou d'une organisation intérieure sophistiquée sur mesure, les lampes DEL mettent en lumière les idées novatrices.

*IDEAS THAT EXCITE
IDEEËN WAAR JE
PLEZIER AAN BELEEFT
DES IDÉES QUI
FONT SOURIRE*





NEBRASKA

SHELL OAK

LOUISIANA

SALBEI SEIDENMATT





In der Küche von heute wird nicht nur gekocht, sie ist zentraler Treffpunkt für schöne Momente. Und ein Ort zum Verweilen, der dank integrierter Thekenlösung zusätzliche Ablagen sowie Sitzmöglichkeiten zugleich bietet.

Today's kitchen is not just somewhere to cook, it's a meeting hub for lovely moments. And, with integrated counter solution, a place to relax while also providing added surface space as well as somewhere to sit.

In de keuken van vandaag wordt niet alleen gekookt, het is ook een centrale ontmoetingsplaats voor gezellige momenten. En een plek om te vertoeven, die dankzij de geïntegreerde baroplossing extra opberg- en zitmogelijkheden biedt.

De nos jours, la cuisine n'est plus seulement destinée à préparer les repas, elle est aussi le lieu de rencontre par excellence pour des moments inoubliables. C'est un endroit où l'on aime s'attarder, assis confortablement au comptoir intégré qui prolonge également le plan de travail.

EINFACH GEMÜTLICH



SCAN ME!

*SIMPLY INVITING
GEWOON GEZELLIG
TOUT SIMPLEMENT
CONFORTABLE*



*RADIANCE NO FINER
STRALEND MOOI
RAYONNANTE DE BEAUTÉ*



**STRALEND..
SCHÖN**

Ob Kalt- oder Warmweiß – leuchtende Akzente in der Küche lassen sich komfortabel und stufenlos per Fernbedienung ansteuern. Auf Wunsch übrigens auch synchron und perfekt aufeinander abgestimmt für ein einheitliches Gesamtbild.

Whether cool or warm white – accent lighting in the kitchen is easily adjusted to any intensity by remote control. Incidentally, it can also be synchronised and perfectly coordinated for a consistent overall impression.

Koud of warm wit – verlichte accenten in de keuken kunnen handig en traploos worden bediend met een afstandsbediening. Op verzoek kunnen ze ook worden gesynchroniseerd en perfect op elkaar worden afgestemd voor een uniform totaalbeeld.

Lumière blanc froid ou blanc chaud, la télécommande permet de régler en continu la température de couleur. Si souhaité, il est possible de synchroniser et d'assortir l'éclairage pour que l'harmonie règne dans la cuisine.





NEBRASKA

EICHE SAND

NEW MEXICO

POLARWEISS HOCHGLANZ





BESTENS

IM BLICK

*EVERYTHING IN VIEW
ALLES IN HET ZICHT
TOUT SOUS LES YEUX*



Immer alles im Blick in unseren serienmäßigen Vollauszügen: Individuell wählbare Innenausstattungen in pflegeleichten Materialausführungen garantieren, dass alles schnell zur Hand ist und stets Ordnung herrscht. Nachhaltig schön sind Lösungen aus echtem Holz.

Our standard full extension drawers reveal everything: selectable interior fittings in easy care materials not only make sure everything is quickly to hand but always in neat order. Solutions in real wood are lovely and perfectly sustainable.

Altijd alles in het zicht in onze standaard volledig uittrekbare laden: individueel te kiezen interieuruitrustingen in onderhoudsvriendelijke materiaaluitvoeringen garanderen dat alles snel bij de hand is en altijd netjes blijft. Oplossingen van echt hout zijn duurzaam mooi.

Avoir une vue globale sur tout ce qui est dans nos coulissants à sortie totale en série : les équipements intérieurs au choix, faciles d'entretien, mettent de l'ordre afin d'avoir rapidement tout sous la main. Les solutions en bois véritable sont élégantes et durables.



SCAN ME!

PRAKTISCH –
das Kochfeld mit integriertem Dunstabzug.
Die Kaffeemaschine kommt Genießern auf
einem ausziehbaren Tablar entgegen. Aus
dem Schubkasten darunter klappt sich auf
Wunsch eine Brotschneidemaschine aus.
So komfortabel lässt es sich gut leben.

PRACTICAL – the hob with integrated downdraft
extractor. The coffee maker comes out to meet the
barista on a pull-out surface. For anyone wanting one,
a bread slicer rises out of the drawer below. Life is as
convenient as this.

PRAKTISCH – de kookplaat met geïntegreerde
afzuiging. De koffiemachine komt fijnproevers op een
uittrekbaar plateau tegemoet. Een broodsnijmachine
verschijnt desgewenst uit de lade eronder. Dit is
comfortabel leven.

PRATIQUE – La table de cuisson avec hotte intégrée.
Placée sur une tablette télescopique, la machine à café
vient à la rencontre des gourmets. Sur demande, une
trancheuse à pain pliable se cache dans le tiroir en
dessous. Pour le confort au quotidien.



PIFFIG GESTALTET

Ob mit Baguettetasche oder Flaschenhalter, Gewürzaufbewahrung am Herd oder Reinigungsmittelkorb im Spülenschrank – wir haben viele Ideen, die Ihr Küchenleben leichter machen.

CLEVERLY DESIGNED – Whether fabric bread bag or bottle holder, storing spices at the cooker or detergent basket in the sink cabinet – we have all sorts of ideas to make kitchen life so much easier for you.

SLIM ONTWORPEN – Met een stokbroodzak of flessenhouder, kruidenopslag op het fornuis of afwasmiddelenmandje in de spoelkast – wij hebben veel ideeën om uw keukenleven gemakkelijker te maken.

SOLUTION JUDICIEUSE – Sac à pain ou porte-bouteilles, rangement des épices à côté de la table de cuisson ou corbeille pour les produits d'entretien dans le sous-évier : voici quelques-unes de nos idées pour faciliter votre vie dans la cuisine.



SCAN ME!



Eine Designinnovation sind die neuen Durchgangstüren: Sie erlauben diskrete Durchgänge zu Vorrats- und Hauswirtschaftsräumen, die das harmonische Gesamtbild nicht stören. Ein rückschonendes Detail sind Schwerlasttablare für Getränkekränze.

The new through-passage doorways are a design innovation: providing unobtrusive access to storage and utility room spaces that don't spoil the lovely, well-balanced overall picture. As a practical detail, heavy-duty pull-out shelves for bottle crates go easy on back strain.

De nieuwe doorgangsdeuren zijn een designinnovatie: ze maken discrete doorgangen naar voorraadruimtes en bijkeukens mogelijk die het harmonieuze totaalbeeld niet verstoren. Zwaar belastbare plateaus voor drankkratten zijn een rugvriendelijk detail.

Les portes de passage sont une innovation en termes de design : elles dissimulent discrètement le cellier ou l'arrière-cuisine sans perturber l'harmonie visuelle. Les tablettes pour caisse de boissons permettent d'adopter une bonne posture pour éviter les maux de dos.

McALLEN

KITO STAHL







DETAILS, DIE BEGEISTERN

AUF DIE FEINE ART

Wie aus einem Guss wirken Arbeitsflächen und Rückwand. Nahtlos eingefügt unterstreichen die flächenbündigen Funktionszonen fürs Spülen und Kochen die großzügige Ausstrahlung.

NICE SOLUTION

Worktops and splashback come from one and the same mould. Seamlessly integrated, the flush-fitting function zones for sinks and cooking underscore the spacious look.



*DETAILS THAT EXCITE
DETAILS DIE INSPIREREN
DES DÉTAILS QUI FONT CRAQUER*

FIJNZINNIG

De werkbladen en de achterwand zien eruit alsof ze uit één mal zijn gegoten. De naadloos geïntegreerde functionele zones voor spoelen en koken benadrukken de royale uitstraling.

L'ART DE LA CUISINE

Le plan de travail et la crédence semblent avoir été fabriqués d'un seul tenant. Les zones fonctionnelles, intégrées à fleur, pour l'évier et la table de cuisson subliment cet aménagement généreux.



ERGONOMIE

AUF ALLEN EBENEN



*ERGONOMICALLY
PERFECTED
THROUGHOUT
ERGONOMIE OP
ALLE NIVEAUS
ERGONOMIE
À TOUS LES
NIVEAUX*



GEHEEL NAAR WENS

Een hoog geïntegreerde vaatwasser en transportmodules voor borden zijn nuttige ergonomische hulpmiddelen. Praktisch: rekken aan de binnenkant van scharnierende deuren waarin kruiden klaar staan.

SUR MESURE

Un lave-vaisselle surélevé et les range-assiettes mobiles sont des accessoires ergonomiques. L'étagère de porte pour les épices est très pratique.

GANZ NACH WUNSCH

Ein hoch gebauter Geschirrspüler und Transportmodule für Teller sind sinnvolle ergonomische Helfer. Praktisch: Innenregale an Drehtüren, die Gewürze bereithalten.

EVERYTHING JUST AS YOU WANT IT

A raised dishwasher and modular plate carriers make for practical and ergonomic helpers. Practical: racks inside hinged doors to hold spices.



ERGONOMISCH UND NACH MASS

Die exakte Anpassung der Arbeitshöhen ist ein unverzichtbarer Bestandteil jeder Planung. Individuell abgestimmte Schrankmaße entlasten den Rücken und erhöhen den Bedienkomfort enorm. Unser Programm bietet Ihnen eine große Auswahl an Korpshöhen, die perfekt passende Lösungen erlaubt. Die Vielfalt der verschiedenen Schrankhöhen und -tiefen eröffnet Planungsspielraum und ermöglicht eine optimale Ausnutzung des zur Verfügung stehenden Platzes: Höhere und tiefere Schränke garantieren mit jedem zusätzlichen Quadratzentimeter ein Plus an Stauraum. Ihr Fachhändler ermittelt mit Ihnen die für Sie ergonomisch empfehlenswerte Arbeitshöhe. Denn das Maß aller Dinge sind ... Sie.

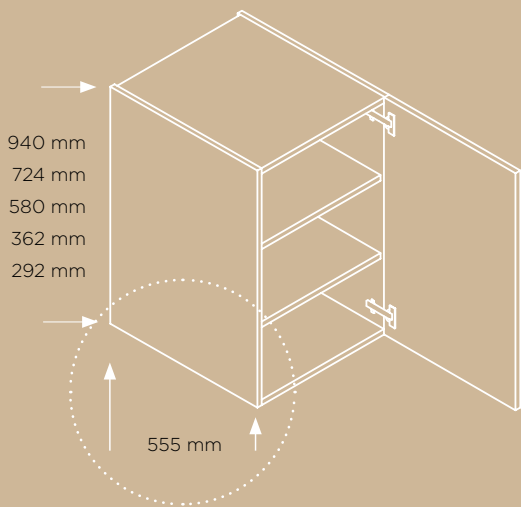

ERGONOMIC AND BESPOKE

Getting working heights exactly right is an indispensable part of planning any kitchen. Cabinets dimensioned to suit those using them reduce back strain and enhance ease of use. Our line-up gives you a wide choice of carcass heights to provide the perfect solution. The many different cabinet heights and depths open up planning flexibility and optimise the use of available space: taller and deeper units provide extra storage space with every additional square centimetre. Your specialist kitchen retailer will help you find the working height that gives you the greatest ergonomic benefit. Because the measure of all things is ... you.

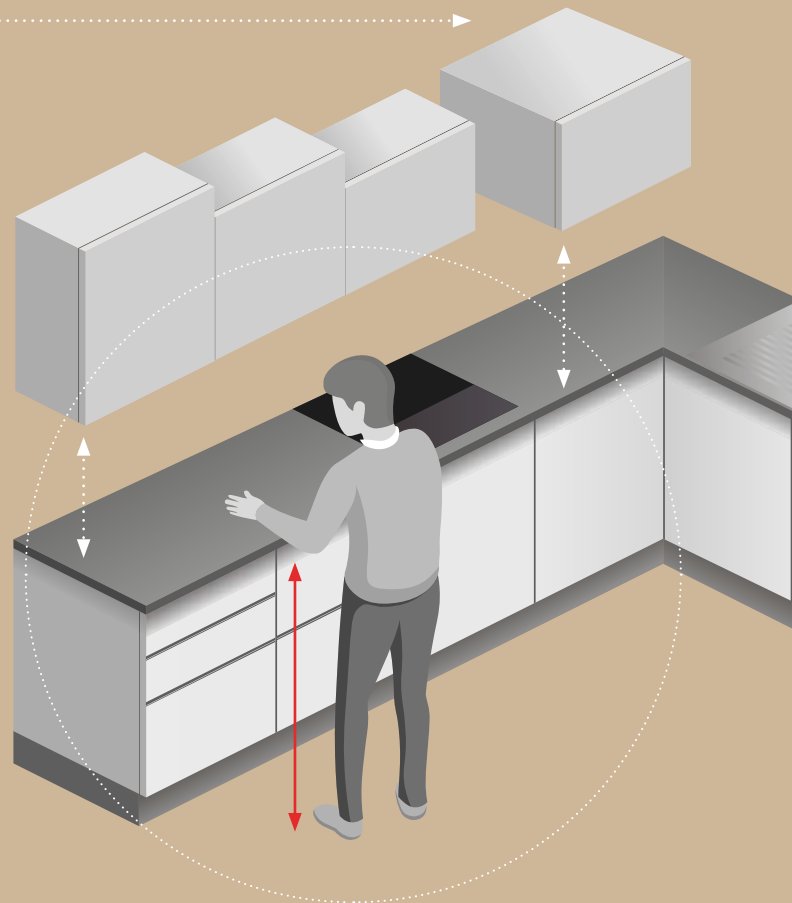

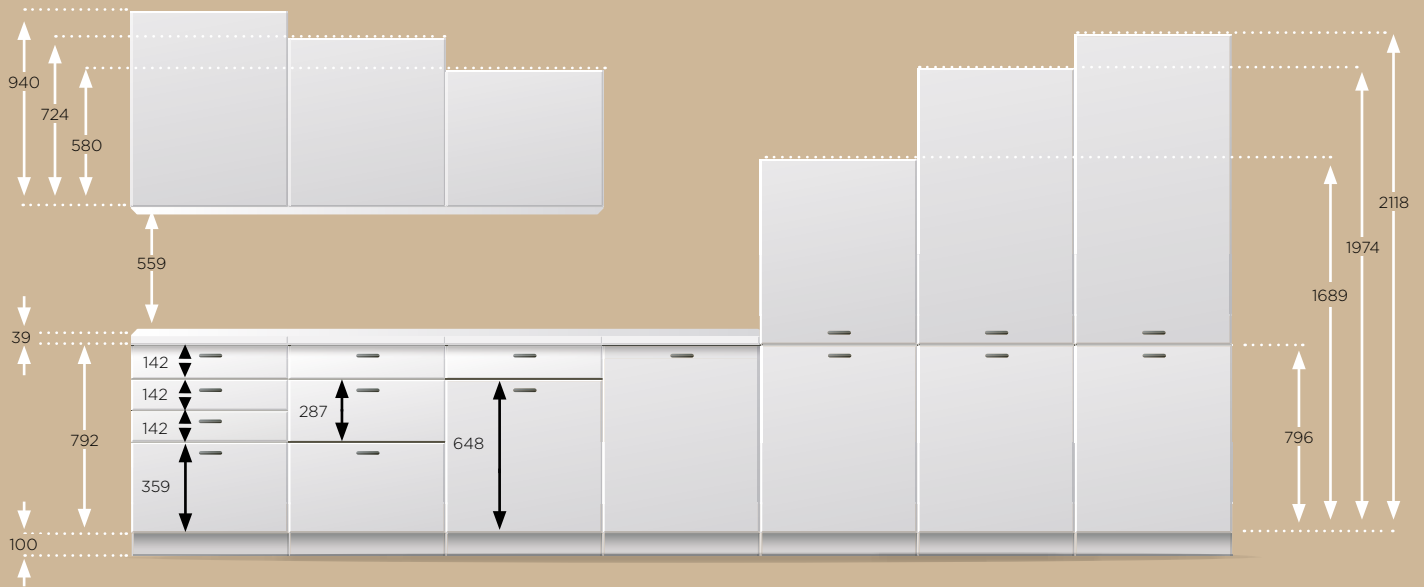

ERGONOMISCH EN OP MAAT

De exacte afstelling van de werkhogte is een onmisbaar onderdeel van elke planning. Individueel aangepaste kastmaten ontlasten de rug en verhogen het gebruikscomfort enorm. Ons programma biedt u een breed scala aan korpushogtes, waardoor perfect passende oplossingen mogelijk zijn. De verscheidenheid aan kashogtes en -dieptes zorgt voor veel planningsmogelijkheden en maakt een optimaal gebruik van de beschikbare ruimte mogelijk: hogere en diepere kasten garanderen meer opbergruimte met elke extra vierkante centimeter. Uw vakhandelaar bepaalt voor u de ergonomisch aanbevolen werkhogte. Maatgevend voor alle dingen bent ... u.

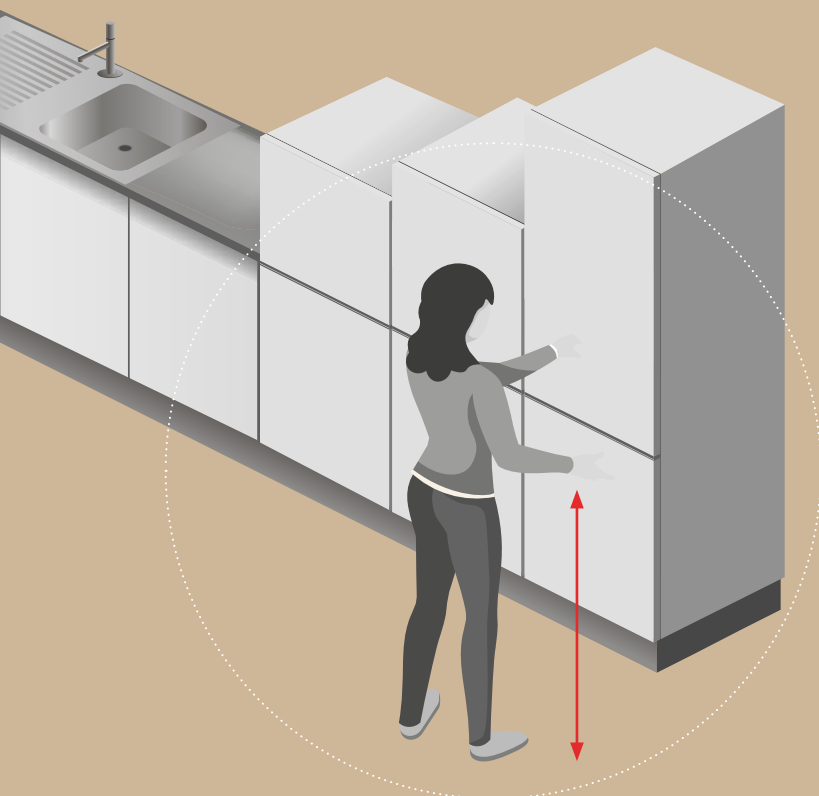

ERGONOMIE ET SUR MESURE

Il est impératif de personnaliser les hauteurs de travail dans chaque planification. Les meubles sur mesure préservent le dos et assurent un niveau de convivialité encore plus élevé. Nous vous proposons un grand choix de hauteurs de corps qui permettent de trouver la meilleure solution. Les nombreuses hauteurs et profondeurs de meubles offrent une grande liberté d'aménagement et optimisent l'espace disponible pour profiter d'un rangement accru en exploitant chaque centimètre carré de la cuisine. Votre revendeur vous aide à trouver votre hauteur de travail ergonomique. Car vous êtes ce qu'il y a de mieux.

ERGONOMIE IM SCHNITTPUNKT

Die Hauptbereiche jeder Küche sind 1. das Kühlen und die Vorratshaltung, 2. das Kochen und 3. das Spülen. Sie bilden die Eckpunkte des Arbeitswege-Dreiecks. Die Wege zwischen ihnen sollten maximal 1,50 Meter lang sein. Das garantiert kurze Wege und Bewegungsspielraum. Die Vorbereitungszone findet ihren Platz zwischen Spüle und Herd und verfügt über mindestens 60 Zentimeter Breite. Vorräte werden nahe des Vorbereitungsplatzes aufbewahrt.

Kochgeschirr und Gewürze sollten am Kochfeld griffbereit sein. Das Arbeitswege-Dreieck lässt sich in nahezu allen Küchenformen und -größen realisieren. Die Anordnung der Schränke erfolgt entsprechend den Arbeitsschritten – für Rechtshänder im Uhrzeigersinn, für Linkshänder in entgegengesetzter Richtung. Mit einer ergonomisch durchdachten Ausstattung lässt sich Ihre Küche so wie eine perfekt eingerichtete Werkstatt auf Ihre Wünsche abstimmen.

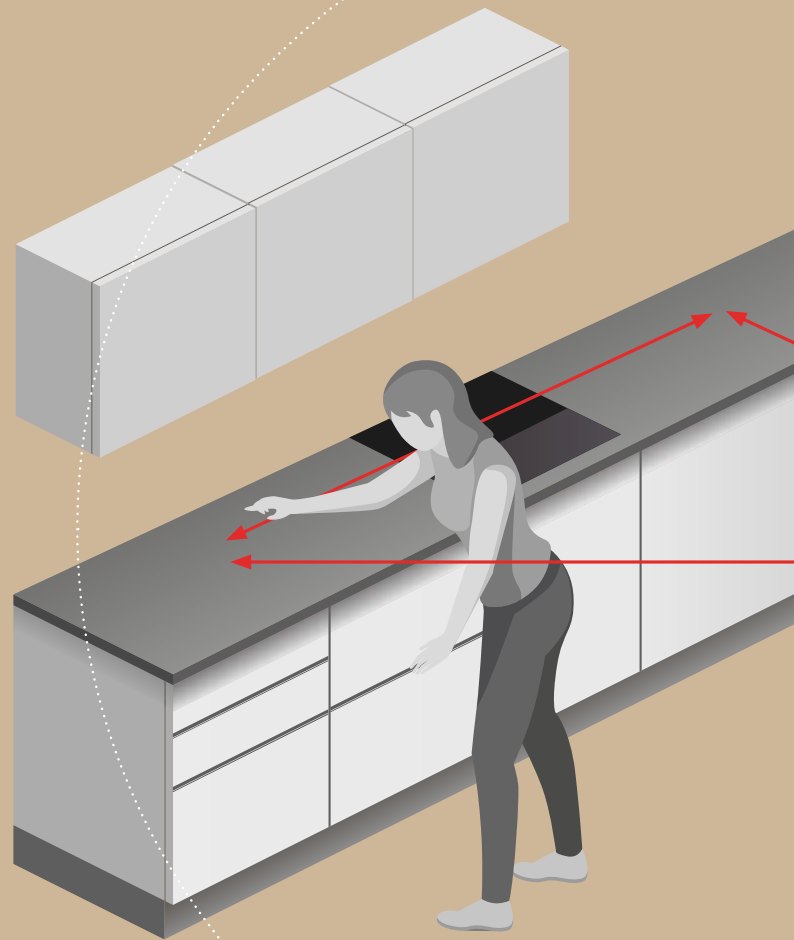

ERGONOMICS AT THE CROSSROADS

The three main zones in any kitchen are 1. refrigeration and food storage, 2. cooking and 3. washing-up. They form the corners of a work triangle. They should be no further than 1.50 metres apart. This guarantees short distances and sufficient room to manoeuvre. The preparation zone is located between the sink and the cooker and is at least 60 centimetres wide. Provisions are kept close to the preparation zone. Cookware and spices should be in easy reach at the hob.

The work triangle can be produced in kitchens of almost any shape and size. Work steps govern the way in which the units are arranged – clockwise for right-handed people and in the opposite direction for the left-handed. Ergonomically designed throughout, your new kitchen can be tailored exactly to your wishes in just the same way as a perfectly equipped workshop.

ERGONOMIE IN DE FOCUS

De drie belangrijkste onderdelen van elke keuken zijn 1. koelen en voorraadopslag, 2. koken en 3. afwassen/spoelen. Zij vormen de hoekpunten van de werkwegdriehoek. De paden ertussen mogen maximaal 1,50 meter lang zijn. Dit garandeert korte afstanden en bewegings-/speelruimte. De voorbereidingszone bevindt zich tussen de spoelbak en het fornuis en is minimaal 60 centimeter breed. Voorraden worden bewaard in de buurt van de voorbereidingszone. Kookgerei en kruiden moeten binnen handbereik zijn bij de kookplaat.

De werkwegdriehoek kan in bijna alle keukenvormen en -afmetingen worden gerealiseerd. De kasten zijn gerangschikt volgens de werkstappen – met de klok mee voor rechtshandigen en in omgekeerde richting voor linkshandigen. Met een ergonomisch doordachte uitrusting kan uw keuken worden afgestemd op uw wensen, net als een perfect uitgeruste werkplaats.

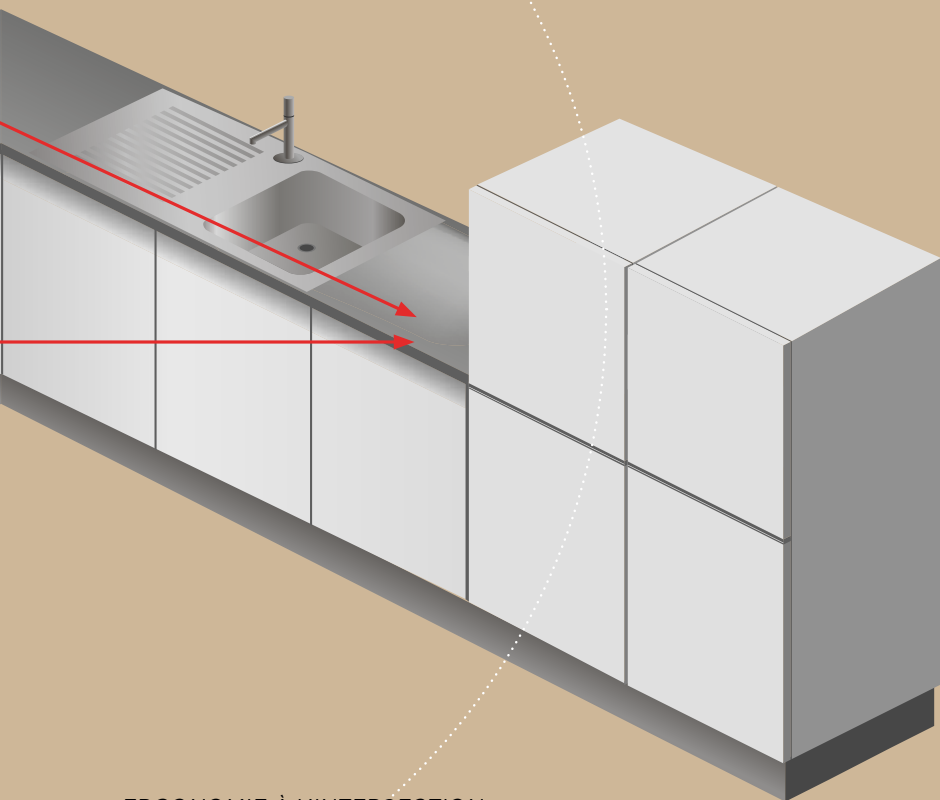

ERGONOMIE À L'INTERSECTION

Chaque cuisine s'organise autour de trois zones : le froid / les provisions, la cuisson et le lavage. Dans le meilleur des cas, elles constituent les sommets du triangle d'activités. Elles ne devraient pas être espacées de plus de 1,50 m, ce qui évite les déplacements inutiles tout en facilitant la circulation. La zone de préparation, au moins 60 cm de large, se situe entre l'évier et la table de cuisson, les provisions sont rangées à côté. Il est conseillé de garder à disposition les casseroles et les épices.

Il est possible de réaliser un triangle d'activités dans presque chaque cuisine, quelle que soit sa forme ou sa taille. Les meubles sont disposés en fonction des tâches à effectuer : dans le sens horaire pour les droitiers, dans le sens antihoraire pour les gauchers. Aménagée en tenant compte de l'ergonomie, votre nouvelle cuisine comblera tous vos souhaits, comme un atelier parfaitement équipé.

ERGONOMISCHE ARBEITSHÖHE

ERGONOMIC WORKING HEIGHT
ERGONOMISCHE WERKHOOGTE
HAUTEUR DE TRAVAIL ERGONOMIQUE

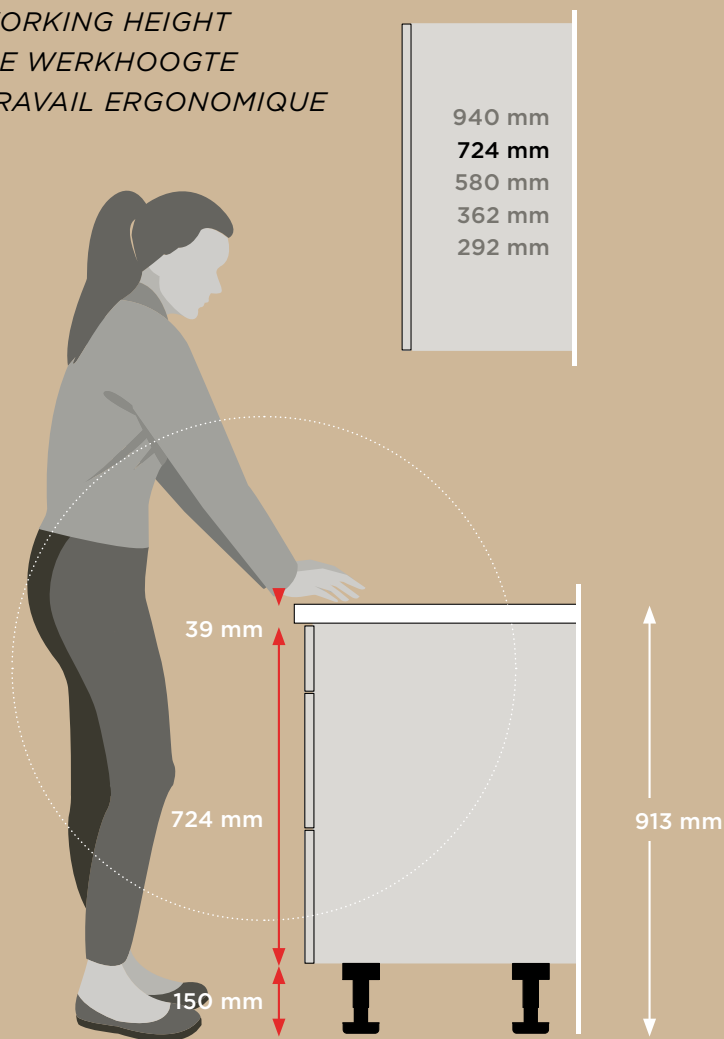

ARBEITSPLETTEN

WORKTOPS WERKBLADEN
PLANS DE TRAVAIL

16 MM | 25 MM | 39 MM

SOCKELHÖHEN

PLINTH HEIGHTS PLINTHOOGTES
HAUTEURS DE SOCLE

75 MM | 100 MM | 125 MM
150 MM | 175 MM | 200 MM

KORPUSTIEFEN

CARCASE DEPTHS KORPUSDIEPTES
PROFONDEURS DE CORPS

335 MM | 455 MM | 555 MM | 705 MM

MIT MASS ZUM KOMFORT

Die Bauhöhe ist nicht alles: Eine Arbeitshöhe ergibt sich immer aus dem Zusammenspiel von Korpus, Arbeitsplatte und Sockel. Ziel ist es, die perfekte Abstimmung für Sie zu finden, um maximalen Komfort in Ihrer Küche zu erreichen. Höhenverstellbare Sockel und Arbeitsplatten in verschiedenen Stärken erlauben zusätzlichen Spielraum für Anpassungen.

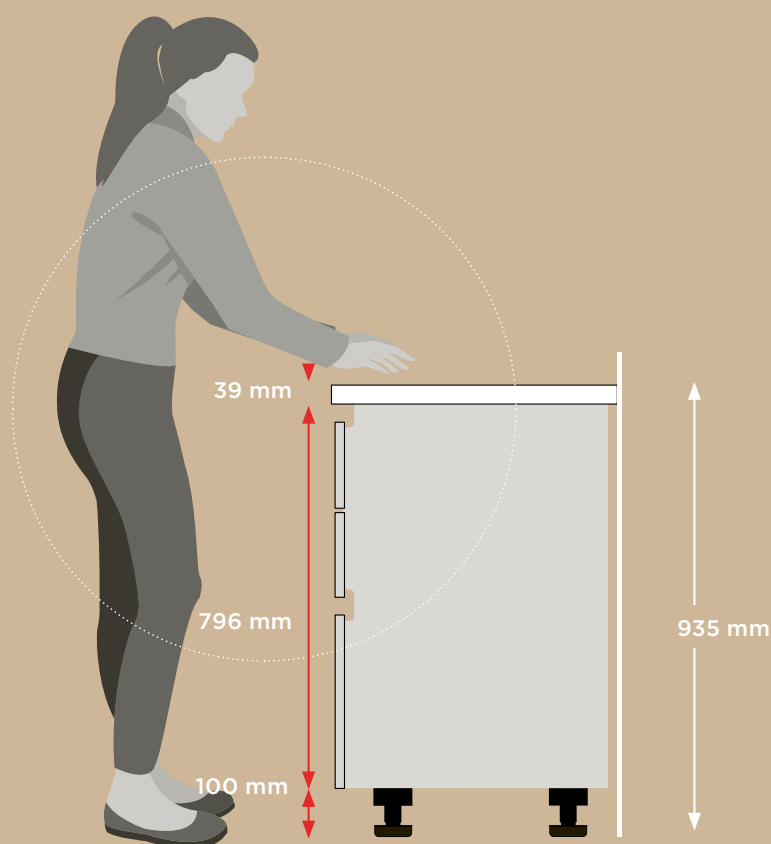

CONVENIENCE THAT MEASURES UP

Overall height isn't everything: working height is always the sum of carcass, worktop and plinth. The aim is to find the perfect balance for you so as to maximise convenience in your kitchen. Height-adjustable plinths and worktops in various thicknesses provide additional scope for getting everything just right.

MAATCOMFORT

De totale hoogte is niet alles: een werkhoogte is altijd het resultaat van de interactie tussen korpus, werkblad en plint. Het doel is om voor u de perfecte match te vinden voor maximaal comfort in uw keuken. In hoogte verstelbare plinten en werkbladen in verschillende diktes bieden extra speelruimte voor aanpassingen.

CONFORT SUR MESURE

La hauteur de planification n'est pas tout : la hauteur de travail dépend toujours des corps, plan de travail et socle. L'objectif est de trouver la vôtre afin que vous ayez le maximum de confort dans votre cuisine. En outre, les socles réglables en hauteur et les plans de travail en plusieurs épaisseurs assurent un ajustement encore plus précis.

GENUSS BRAUCHT ORDNUNG



Ob Messerblock, Platz für Gewürze oder für 1000 andere Dinge, die das Kochen schöner machen: Unsere Innenausstattungen passen sich Ihren Wünschen an. Es gibt sie in verschiedenen Größen und auf Wunsch mit modularer Einteilung nach Maß. Aus Echtholz oder hochwertigem Kunststoff.



LOVERS OF ORGANISATION

Whether knife block, spices rack or all sorts of other things that make cooking such a pleasure: our interior fittings give you everything you want. They come in different sizes and, on request, with bespoke modular partitioning. In real wood or high-quality plastic.

ALLES NETJES IS EEN GENOT

Of het nu gaat om het messenblok, ruimte voor kruiden of voor de 1000 andere dingen die het koken aangenamer maken: onze interieuruitrusting past zich aan uw wensen aan. Ze zijn verkrijgbaar in verschillende afmetingen en, op verzoek, met modulaire indeling op maat. Van echt hout of hoogwaardige kunststof.

ALLIER PLAISIR ET ORDRE

Qu'il s'agisse de bloc couteaux, de place pour les épices ou pour les milliers d'autres choses qui embellissent la cuisine : nos équipements intérieurs répondent à vos souhaits. Ils sont disponibles en plusieurs tailles et, sur demande, modulables. En bois véritable ou en plastique haut de gamme.



McALLEN

SAND



NATURAL AMBIENCE
NATUURLIJKE AMBIANCE
AMBIANCE NATURELLE

NATÜRLICHES AMBIENTE



ALLES AN SEINEM PLATZ



Wir denken Stauraum neu – zum Beispiel mit unseren herausnehmbaren Tellerhaltern in geräumigen Auszügen oder schmalen Reinigungsmittelkörben im Spülenunterschrank.

We are rethinking storage space – with features like our removable plate holders in spacious pull-outs or narrow detergent baskets in the sink cabinet.

We hebben opberg ruimte opnieuw uitgedacht – bijvoorbeeld met onze uitneembare bordenhouders in ruime uittrekelementen of smalle manden voor reinigingsmiddelen in de spoelonderkast.

Nous réinventons l'espace de rangement – par exemple, avec nos portes-assiettes amovibles dans les coulissants géants ou avec les paniers étroits pour les produits d'entretien dans le sous-évier.



GELUNGENER ABSCHLUSS – Unsere neuen Deckenblenden perfektionieren besonders großzügige, deckenhohe Planungen und öffnen weitere Stauraumoptionen.

TOPPING IT ALL – Opening up further storage options, our new top front panels make particularly spacious, ceiling-height units just perfect.

GESLAAGDE AFRONDING – onze nieuwe plafondpanelen zijn perfect voor bijzonder ruime, plafondhoge indelingen en bieden nog meer opbergmogelijkheden.

FINITION RÉUSSIE – Nos bandeaux de finition subliment les planifications généreuses jusqu'au plafond et optimisent le rangement.

*EVERYTHING IN ITS PLACE
ALLES OP ZIJN PLEKJE
TOUT EST PARFAITEMENT
BIEN RANGÉ*





GEORGIA McALLEN

GREIGE SEIDENMATT

MOCCA



IN SCHÖNSTER HARMONIE

*IN LOVELY HARMONY
IN ESTHETISCHE HARMONIE
TOUT EN HARMONIE*

IOWA

SALBEI SEIDENMATT
GREIGE SEIDENMATT









KANSAS
GREIGE SEIDENMATT



Ton in Ton: Die seidenmatt lackierte Rahmenfront begeistert mit sorgfältiger handwerklicher Verarbeitung im sanften Farbton Greige. Landhausgriffe, Vitrinenschränke und Sichtseiten mit Paneelwirkung unterstreichen den sympathischen Cottage Style.

WITH HUGE AURA

Tone in tone: the silky matt lacquered framed front captivates with meticulous craftsmanship in the subtle shade of greige. Country-style handles, glass display cabinets and visible sides with panel effect underscore the appealing Cottage Style.

MET VEEL SFEER

Ton sur ton: het zijdemat gelakte raamwerkfront valt in de smaak met een zorgvuldige handmatige afwerking in de zachte kleur greige. Landhuisgrepen, vitrinekasten en zichtbare zijden met paneleffect onderstrepen de sympathieke cottage style.

AMBIANCE EXCLUSIVE

Ton sur ton : la façade à cadre laqué mat soyeux séduit par une finition artisanale méticuleuse en teinte grège discrète. Les poignées champêtres, les vitrines et les côtés visibles, façon panneaux, soulignent l'élégance du style Cottage.



MIT VIEL
ATMOSPHÄRE





**ELEGANTE
AUSSTRAHLUNG**
Ein Buffett in Vitrinen-Optik
wird zum einzigartigen Blick-
fang. Der sanfte Farbton
Greige bringt das Ensemble
im Zusammenspiel mit Glas
und Licht zum Strahlen. Die
LED-Einbauleuchten **Glaspoint**
sorgen für echte Wow-Effekte.

ELEGANT AURA

A sideboard in glass display cabinet look makes a unique eye-catcher. The soft greige shade makes brings radiance to this ensemble in combination with glass and light. **Glaspoint** LED lights say "wow".

ELEGANTE UITSTRALING

De buffetkast in vitrine-look wordt een unieke blikvanger. De zachte tint Greige laat het geheel schitteren in het samenspel van glas en licht. De **Glaspoint** led-inbouwlampen zorgen voor echte wow-effecten.

RAYONNE D'ÉLÉGANCE

Un buffet, conçu comme une vitrine, attire tous les regards. La teinte grège discrète, associée au verre et à la lumière, illumine l'ambiance de cet aménagement. Les lampes DEL intégrées **Glaspoint** créent un véritable effet de surprise.



SCAN ME!



KANSAS

NEBELGRAU SEIDENMATT

GEORGIA

SCHWARZ SEIDENMATT





KANSAS



KANSAS 370

Weiß seidenmatt
White silky matt
Wit zijdemat
Blanc mat soyeux

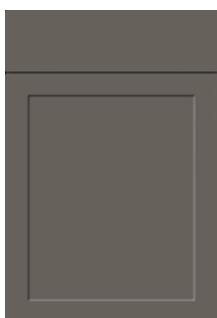

KANSAS 371

Quarzgrau seidenmatt
Quartz grey silky matt
Kwartsgrijs zijdemat
Gris quartz mat soyeux

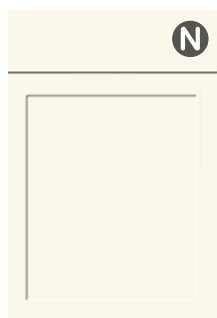

KANSAS 372

Silk seidenmatt
Silk silky matt
Silk zijdemat
Silk mat soyeux

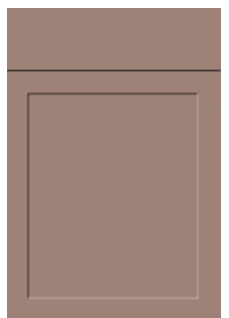

KANSAS 373

Greige seidenmatt
Greige silky matt
Greige zijdemat
Grège mat soyeux



KANSAS 374

Nebelgrau seidenmatt
Mist grey silky matt
Mist grijs zijdemat
Gris brume mat soyeux

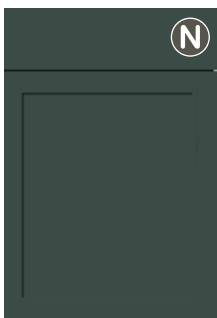

KANSAS 375

Black green seidenmatt
Black green silky matt
Black green zijdemat
Black green mat soyeux

ALLES IM RAHMEN

Ob mit glatter oder erhabener Füllung - Rahmenfronten beweisen Stil und vermitteln Geborgenheit. KANSAS wirkt besonders frisch und modern. IOWA beweist Liebe zum Detail. Die seidenmatt lackierten Oberflächen beider Modelle garantieren in Optik, Haptik und im edlen Finish ein außergewöhnlich schönes Ambiente. Für beide Serien haben wir das farblich passende Umfeld mit z. B. Wangen, Böden, Sockel und Regalen im Programm. Alles nach Maß und Wunsch.

SETTING THE FRAME

Whether with smooth or raised infill panel - framed fronts are a statement of style and convey a homely feel. KANSAS enters the stage with a particularly refreshing and modern look. IOWA demonstrates a love of detail. The silky matt lacquered surfaces give both models an exquisite look, feel and finish to guarantee a delightful ambience second to none. Complementing both ranges, our line-up features surrounding elements in matching colour, such as side, top and bottom panels, shelves and plinths. All made to measure and exactly to your liking.



IOWA

ALLES MOOI INGEKADERD

Met glad of gestructureerd binnenpaneel - raamwerkfronten stralen stijl uit en geven een gevoel van geborgenheid. KANSAS heeft een bijzonder frisse en moderne uitstraling. IOWA toont liefde voor details. De zijdematte lakoppervlakken van beide modellen staan garant voor een buitengewoon mooie ambiance wat betreft uiterlijk, gevoel en stijlvolle afwerking. Voor beide series hebben we de bijpassende kleuromgeving met o.a. stollenwanden, legplanken, plinten en open kasten in ons assortiment. Alles op maat en naar wens.

TOUT DANS UN CADRE

Avec un panneau central lisse ou en relief, les façades à cadre témoignent de notre savoir-faire en matière de style et créent une ambiance chaleureuse. KANSAS semble fraîche et moderne. IOWA affiche son amour pour les détails. Les surfaces laquées mat soyeux de ces deux modèles apportent une allure chic et élégante en termes de visuel, de toucher et de finition. Pour ces deux séries, nous proposons des éléments assortis, par ex. joues, tablettes, socles et étagères. Tout sur mesure.



IOWA 435

Sandbeige seidenmatt
Sand beige silky matt
Zandbeige zijdemat
Beige sable mat soyeux

IOWA 436

Moonlight grey seidenmatt
Moonlight grey silky matt
Moonlight grey zijdemat
Moonlight grey mat soyeux

IOWA 437

Salbei seidenmatt
Sage silky matt
Salie zijdemat
Sauge mat soyeux

IOWA 438

Silk seidenmatt
Silk silky matt
Silk zijdemat
Silk mat soyeux



IOWA 439

Weiß seidenmatt
White silky matt
Wit zijdemat
Blanc mat soyeux

IOWA 446

Quarzgrau seidenmatt
Quartz grey silky matt
Kwartsgrijs zijdemat
Gris quartz mat soyeux

IOWA 448

Schwarz seidenmatt
Black silky matt
Zwart zijdemat
Noir mat soyeux

IOWA 449

Greige seidenmatt
Greige silky matt
Greige zijdemat
Grège mat soyeux

GEFÜHL FÜR STIL

*SENSE OF STYLE
GEVOEL VOOR STIJL
LE SENS DU STYLE*



IOWA

SILK SEIDENMATT





IN SCHÖNSTER FRISCHE

Weiß, Glas und Lichtakzente vermitteln Leichtigkeit. Der pfiffig konzipierte Eckschrank **Space Corner** beweist sein Stauraumtalent im Alltag. Auf ein neues Wohngefühl!

Wonderfully refreshing

White, glass and accent lighting conjure a light and airy feel. The cleverly designed **Space Corner** unit demonstrates its talent as a provider of storage space in everyday use. Here's to a new feeling of home living!

Heerlijke frisheid

Wit, glas en lichtaccenten zorgen voor een lichte sfeer. De slim ontworpen hoekkast **Space Corner** bewijst zijn opbergtalent elke dag opnieuw. Verheug u op een nieuw woongevoel!

Un souffle de fraîcheur

Blanc, verre et touches lumineuses pour plus de légèreté. Le meuble d'angle **Space Corner** astucieux multiplie les options de rangement. Au nouvel art d'habiter !



SCAN ME!





*FACETS THAT BRING JOY
SMAAKVOLLE FACETTEN
C'EST UNE JOIE PURE*



Facetten

VOLLER FREUDE







GEORGIA

POLARWEISS
SEIDENMATT





*TIMELESS APPEAL
TIJDLOZE SCHOONHEID
BEAUTÉ INTEMPORELLE*

ZEITLOSE SCHÖNHEIT

Nuancen erwecken Einrichtungen zum Leben und werden von Lichtquellen gezielt in Szene gesetzt. Besonderer Hingucker: Rauchglas für den modernen Touch.

Nuances bring furnishings to life and are shown off with stunning effect by sources of light. Particular eye-catcher: smoked glass for a modern touch.

Nuances brengen meubels tot leven en worden specifiek geënsceeneerd door lichtbronnen. Bijzondere blikvanger: rookglas voor een moderne touch.

Les nuances subliment les équipements et les sources lumineuses les mettent subtilement en scène. Attire toujours l'attention : le verre fumé pour une touche moderne.

ANTI-FINGERPRINT

OBERFLÄCHE

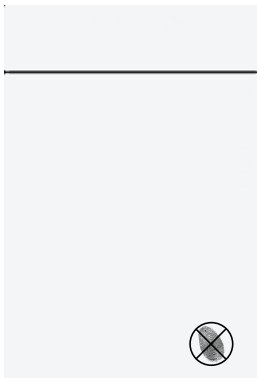

GEORGIA 275
Weiß seidenmatt
 White silky matt
 Wit zijdemat
 Blanc mat soyeux



GEORGIA 276
Greige seidenmatt
 Greige silky matt
 Greige zijdemat
 Grège mat soyeux

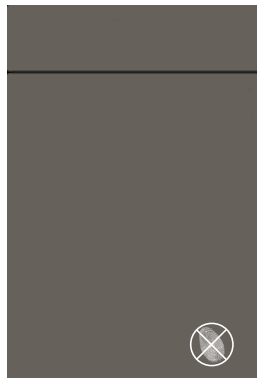

GEORGIA 277
Quarzgrau seidenmatt
 Quartz grey silky matt
 Kwartzgrijs zijdemat
 Gris quartz mat soyeux

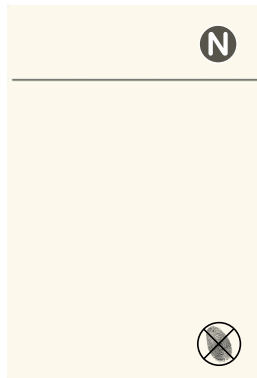

GEORGIA 278
Silk seidenmatt
 Silk silky matt
 Silk zijdemat
 Silk mat soyeux

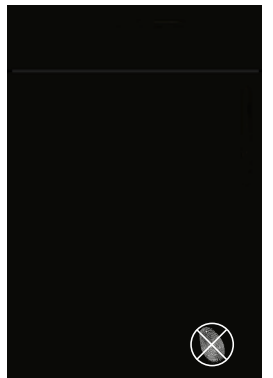

GEORGIA 279
Schwarz seidenmatt
 Black silky matt
 Zwart zijdemat
 Noir mat soyeux

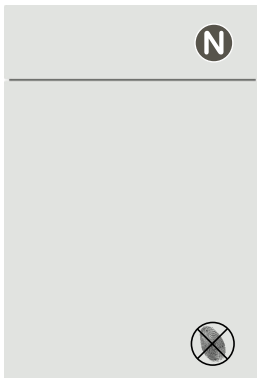

GEORGIA 280
Moonlight grey seidenmatt
 Moonlight grey silky matt
 Moonlight grey zijdemat
 Moonlight grey mat soyeux

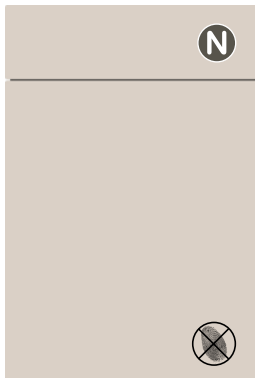

GEORGIA 281
Sandbeige seidenmatt
 Sand beige silky matt
 Zandbeige zijdemat
 Beige sable mat soyeux

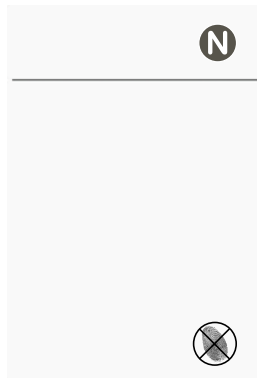

GEORGIA 282
Polarweiß seidenmatt
 Polar white silky matt
 Polarwit zijdemat
 Blanc polaire mat soyeux

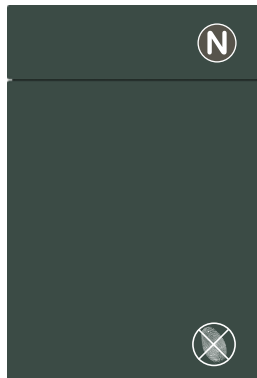

GEORGIA 286
Black green seidenmatt
 Black green silky matt
 Black green zijdemat
 Black green mat soyeux

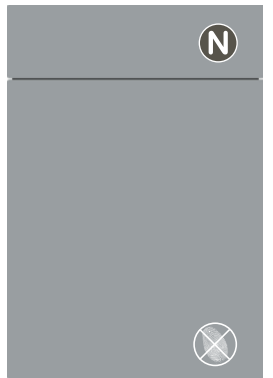

GEORGIA 287
Nebelgrau seidenmatt
 Mist grey silky matt
 Mist grijs zijdemat
 Gris brume mat soyeux

GEORGIA



Keine Chance für Fingerabdrücke: Dank des Anti-Fingerprint-Effektes vereint GEORGIA eine außergewöhnlich schöne Optik mit Pflegeleichtigkeit. Die robusten Oberflächen nehmen so schnell nichts übel, was an dem verwendeten UV-Lack liegt, der im Gießverfahren aufgetragen wird. Beim Aushärten setzen wir eine konzentrierte UV-Strahlung in Verbindung mit Nanopartikeln ein, was für einen einzigartigen Look, Feel & Touch sorgt.

ANTI-FINGERPRINT SURFACE FINISH

This is where finger marks don't stand a chance: benefiting from the anti-fingerprint effect, GEORGIA combines exceptional beauty with easy maintenance. The hard-wearing surfaces take everything in their stride, which is all down to the UV lacquer coating that's applied in a type of casting process. At the curing stage, we use concentrated UV radiation in combination with nano particles to provide a unique look, feel and touch.

ANTI-FINGERPRINT-OPPERVLAK

Geen kans voor vingerafdrukken: dankzij het Anti-fingerprint-effect combineert GEORGIA een uitzonderlijk mooie look met onderhoudsgemak. De robuuste oppervlakken zijn zeer vergevingsgezind, wat te danken is aan de gebruikte UV-lak, die in een gietprocedé wordt aangebracht. Bij het uitharden gebruiken we geconcentreerde UV-straling in combinatie met nanodeeltjes, wat zorgt voor een unieke look, feel & touch.

SURFACE ANTI-TRACES DE DOIGTS

Finies les traces de doigts : grâce à un revêtement spécial, GEORGIA allie élégance exceptionnelle et entretien facile. Les surfaces robustes supportent les traitements les plus rudes, ce qui est dû à la laque UV utilisée, appliquée en machine à rideau. Pour le durcissement, nous misons sur un rayonnement UV concentré, associé à des nanoparticules, ce qui permet d'obtenir une surface au design, à la finesse et au toucher exceptionnels.







LOUISIANA

GREIGE



LOUISIANA
WEISS SEIDENMATT





NEAT SOLUTIONS

Household helpers at an ergonomic height, like this heavy-duty unit, are always a good idea. There's even storage space left over in room corners or under the sink. Good planning makes efficient use of every last inch in the utility room.

FRAAIE OPLOSSINGEN

Huishoudhulpjes op ergonomische hoogte, zoals in deze zwaar belastbare kast, zijn altijd een goed idee. Er is zelfs opbergruimte in de hoeken van de kamer of onder de gootsteen. Met een goede planning kan elke vierkante centimeter in de bijkeuken efficiënt worden gebruikt.

SOLUTIONS PROPRES

L'électroménager à hauteur ergonomique, comme dans ce meuble très résistant, est toujours une bonne idée. Des espaces de rangement ont même été prévus dans le meuble d'angle ou sous l'évier. Une bonne planification permet ainsi d'exploiter efficacement chaque centimètre carré dans l'arrière-cuisine.



Haushaltshelfer auf ergonomischer Höhe wie in diesem hochbelastbaren Schranktyp sind immer eine gute Idee. Stauraum-Reserven stecken selbst in Zimmerecken oder unter der Spüle. Mit guter Planung lässt sich im Hauswirtschaftsraum so jeder Quadratzentimeter effizient nutzen.

SAUBERE LÖSUNGEN



CLEVER EINGERICHTET

*CLEVERLY FURNISHED
SLIM INGERICHT
AMÉNAGEMENT JUDICIEUX*

MAXIMAL FUNKTIONAL:

Zur Ausstattung von Hauswirtschaftsräumen haben wir neben Hochschranktypen mit extra viel Stauraum zahlreiche raffiniert geplante Ausstattungshighlights im Programm. Mit ihnen lässt sich der zur Verfügung stehende Platz optimal ausnutzen und höchst individuell planen.

MAXIMUM PRACTICALITY:

In addition to tall unit types with an extra lot of storage space, our product range also features cleverly planned highlights for configuring utility rooms. They make optimum use of available space and provide maximum planning flexibility to suit any situation.

MAXIMAAL FUNCTIONEEL:

Voor de inrichting van bijkeukens bieden wij behalve hoge kasten met extra veel opbergruimte talrijke, geraffineerd geplande inrichtingsdetails. Hiermee kan de beschikbare ruimte optimaal benut en zeer individueel gepland worden.

LE MAXIMUM DE FONCTIONNALITÉ :

Pour aménager l'arrière-cuisine, nous proposons outre les armoires très spacieuses de nombreuses options et accessoires judicieux dans notre programme. Ils permettent d'utiliser pleinement la place disponible et de l'aménager sur mesure.





LEUCHTENDES

BEISPIEL



SHINING EXAMPLE
LICHTEND VORBEELD
EXEMPLE LUMINEUX

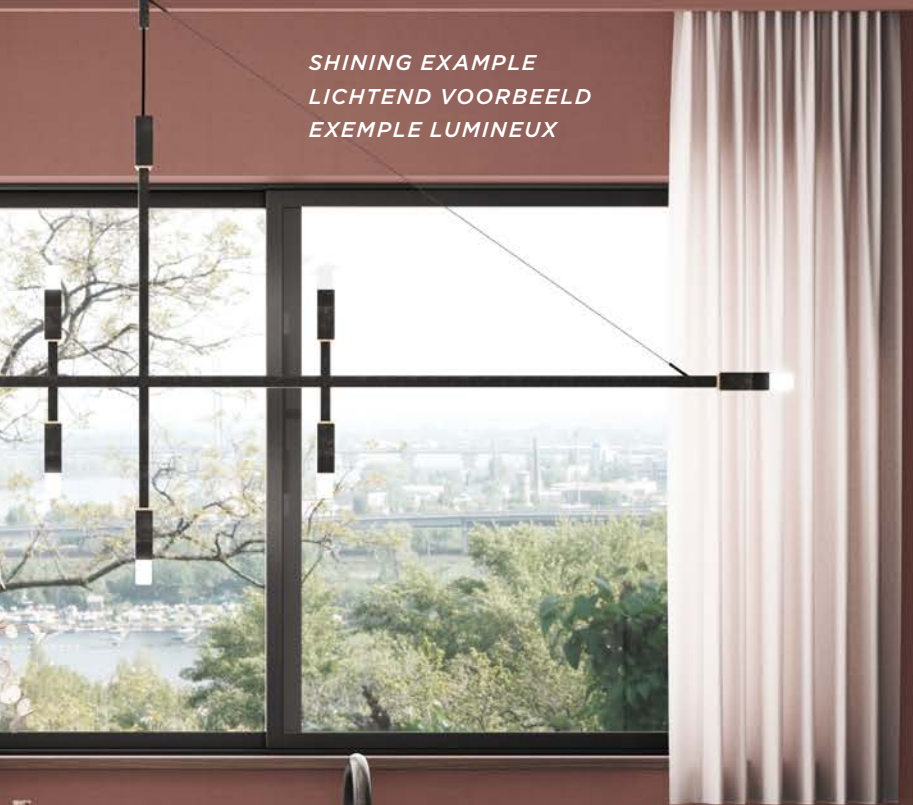

NEBRASKA LOUISIANA

COFFEE OAK

MARSHMALLOW SEIDENMATT



LOUISIANA

MARSHMALLOW SEIDENMATT



LOUISIANA

GREIGE



LOUISIANA

BLACK GREEN
SEIDENMATT

SAALERNO

SOFT GROOVE







PENNSYLVANIA

QUARZGRAU SEIDENMATT



OUR FAVOURITE PLACE

Our multi-talented **Easy** splashback railing system gets everything looking neat and tidy in seconds flat. Clever and practical: the **Denver** LED shelf light is a storage surface and glare-free light source all in one.

ONS LIEVELINGSPLEKJE

Ons nisrelingsysteem **Easy** is een multitalent dat in een mum van tijd orde schept. Geraffineerd en praktisch: led-plankverlichting **Denver** is een niet-verblindende lichtbron, maar biedt ook opbergruimte.

NOTRE PLACE PRÉFÉRÉE

Toujours parfaitement organisée, notre main courante de crédence **Easy** met de l'ordre en un tournemain. Le luminaire DEL pour tablette éclairée **Denver**, pratique et judicieux, sert de surface de rangement et source d'éclairage tamisé.



UNSER LIEBLINGSPLATZ

Als Multitalent präsentiert sich unser Nischenrelingsystem **Easy**, das im Handumdrehen Ordnung schafft. Raffiniert und praktisch: Die LED-Regalbodenleuchte **Denver** ist Ablagefläche und blendfreie Lichtquelle in einem.





ERHELLENDE AUSSICHTEN

Mit Lichtakzenten lässt sich Schönes in Szene setzen:
Die Anbauleuchte **Glaspoint** haben wir für herkömmliche
Regalböden und als zweiseitig strahlende Variante im
Programm. Sie verleiht Möbeln mit Glas eine faszinierende
Raumwirkung. Als dimmbare, stufenlos in der
Farbtemperatur regelbare LED-Ausführung -
optional auch per Smart Living steuerbar.

BRIGHT PROSPECTS

Accent lighting sets the stage for lovely pieces:
we can give you the **Glaspoint** surface-mounted light for conventional
shelves as well as in the form of an option that illuminates from both
sides. It gives a fascinating feeling of space to furniture with elements
of glass. As a dimmable LED version with infinitely variable colour
temperature - by way of option, also controllable via Smart Living.



VERLICHTE UITZICHTEN

Mooie spullen kunnen met lichtaccenten fraai in scène worden gezet: de **Glaspoint** opbouwarmatuur is bij ons verkrijgbaar voor conventionele legplanken en als tweezijdig stralende variant. Hij geeft meubels met glas een fascinerend ruimtelijk effect. Als dimbare, qua kleurtemperatuur traploos regelbare led-uitvoering - optioneel ook regelbaar via Smart Living.

PERSPECTIVES LUMINEUSES

Utiliser la lumière pour mettre en valeur les objets décoratifs : nous proposons l'applique **Glaspoint** pour les tablettes d'étagère traditionnelles et comme modèle éclairant de deux côtés. Elle confère aux meubles en verre une incroyable sensation d'espace. Disponible en finition DEL, avec intensité variable et température de couleur réglable en continu, commande via Smart Living en option.

PENNSYLVANIA

IN GROSSER KLARHEIT
Geradlinig in der Formensprache
begeistern die Designküchen
PENNSYLVANIA und **PORTLAND**
mit ihrer puren Ästhetik. Ob mit
Griffen oder ohne, mit passenden
Sichtseiten oder mit Akzentfarben
realisiert – der hochwertige
Frontlack spiegelt Klasse und
Anspruch wider. Sie haben die
Wahl zwischen **PENNSYLVANIA**
in einer eleganten seidenmatten
Lackierung und **PORTLAND**,
die mit einer repräsentativen
hochglanzlackierten Front die
Blicke auf sich zieht.



CLEAR STATEMENT

Sleek and stylish, our PENNSYLVANIA and PORTLAND designer kitchens simply excite with unadulterated aesthetic appeal. Whether with or without handles, with matching visible sides or with accent colours – the high-quality front lacquer reflects class and discerning taste. You have the choice between PENNSYLVANIA in an elegant, silky matt lacquer finish and PORTLAND, which attracts attention with a prestigious-looking front in high-gloss lacquer.

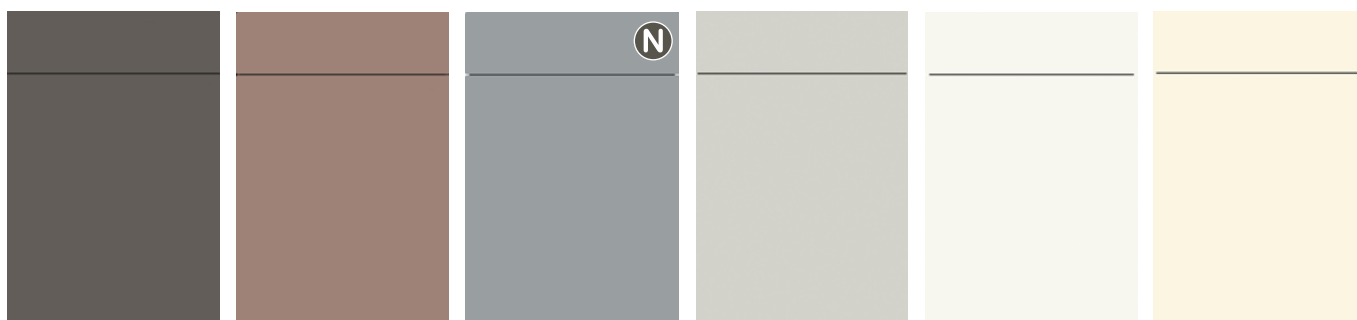

PENNSYLVANIA 356
Quarzgrau seidenmatt
Quartz grey silky matt
Kwartsgrijs zijdemat
Gris quartz mat soyeux

PENNSYLVANIA 357
Greige seidenmatt
Greige silky matt
Greige zijdemat
Grège mat soyeux

PENNSYLVANIA 358
Nebelgrau seidenmatt
Mist grey silky matt
Mist grijs zijdemat
Gris brume mat soyeux

PENNSYLVANIA 389
Moonlight grey seidenmatt
Moonlight grey silky matt
Moonlight grey zijdemat
Moonlight grey mat soyeux

PENNSYLVANIA 391
Weiß seidenmatt
White silky matt
Wit zijdemat
Blanc mat soyeux

PENNSYLVANIA 392
Silk seidenmatt
Silk silky matt
Silk zijdemat
Silk mat soyeux

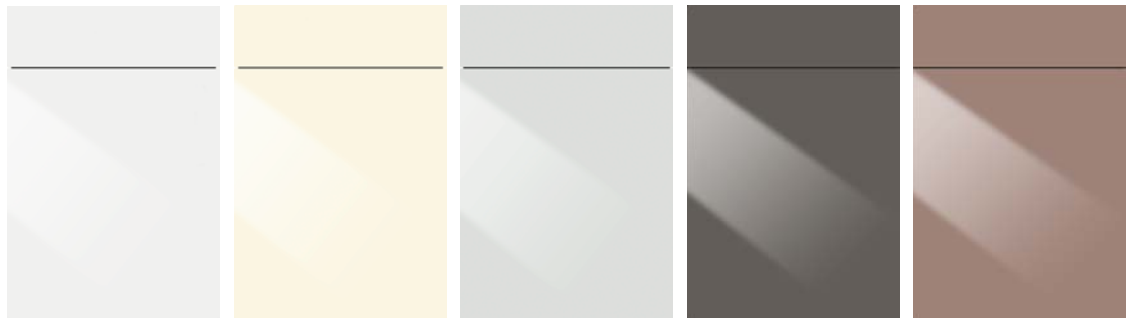

PORTLAND 380

Weiß Hochglanz
White high-gloss
Wit hoogglans
Blanc brillant

PORTLAND 383

Silk Hochglanz
Silk high-gloss
Silk hoogglans
Silk brillant

PORTLAND 384

Moonlight grey Hochglanz
Moonlight grey high-gloss
Moonlight grey hoogglans
Moonlight grey brillant

PORTLAND 385

Quarzgrau Hochglanz
Quartz grey high-gloss
Kwartsgrijs hoogglans
Gris quartz brillant

PORTLAND 387

Greige Hochglanz
Greige high-gloss
Greige hoogglans
Grège brillant

PORTLAND



IN GROTE HELDERHEID

De strak vormgegeven designkeukens PENNSYLVANIA en PORTLAND overtuigen met hun pure esthetiek. Met of zonder grepen, met bijpassende zichtzijden of uitgevoerd in accentkleuren - de hoogwaardige frontlak weerspiegelt klasse en aspiratie. U heeft de keuze tussen PENNSYLVANIA in een elegante zijdematte lakafwerking en PORTLAND, die in het oog springt met een prestigieus hoogglanzend gelakt front.

D'UNE GRANDE CLARTÉ

Grâce à leurs lignes épurées, les cuisines PENNSYLVANIA et PORTLAND séduisent par les traits fins et délicats de leur design. Avec ou sans poignée, avec des côtés visibles assortis ou des contrastes frappants, les façades laquées exclusives reflètent la classe et l'élégance. Vous avez le choix entre PENNSYLVANIA qui se distingue par ses façades laquées mat soyeux et PORTLAND dont les façades laquées brillant attirent tous les regards.



LOUISIANA

STORMGREY SEIDENMATT/
ALMOST BLUE SEIDENMATT







KENTUCKY

CONCRETE GREY

GEORGIA

SCHWARZ SEIDENMATT



**Außergewöhnliche Dimensionen:
Neue Pult- und Thekenplatten
in 90 mm setzen ein markantes
Zeichen in der modernen Küche.**

Dimensions beyond the norm: new bar and counter tops in 90 mm make a mark of distinction in the modern kitchen.

Buitengewone dimensies: nieuwe dikke werkbladen en barbladen van 90 mm brengen opvallende accenten aan in de moderne keuken.

Dimensions exceptionnelles : les nouveaux plans de travail épais et comptoirs, 90 mm d'épaisseur, sont un signe particulier de la cuisine moderne.

PULT- UND THEKENPLATTEN

90 MM

BAR AND COUNTER TOPS 90 MM
DIKKE WERKBLADEN & BARBLADEN 90 MM
PLANS DE TRAVAIL ÉPAIS ET COMPTOIRS 90 MM



882 Grain hell
882 Grain light
882 Grain licht
882 Grain clair



889 Concrete grey



891 Grain Cognac



893 Arizona Pine



898 Concrete anthracite



937 Historic Oak



941 Black burned



942 Natural Oak



953 Alpine Oak



956 Elegant brown



957 Saloon

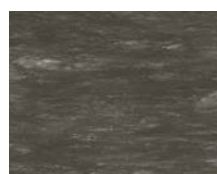

961 Skyfall



967 Wild Oak



969 Marmor Grigio



970 Marmor Bianco



973 Terra



978 Marmor Nero

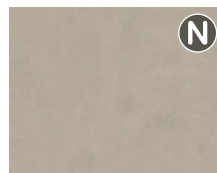

979 Sand
979 Zand



981 Honey Oak

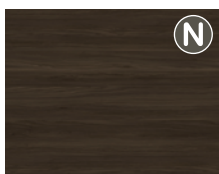

982 Coffee Oak

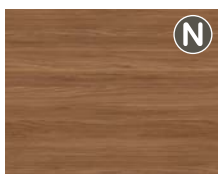

983 Amber Oak



McALLEN NEW MEXICO

KITO STAHL

POLARWEISS HOCHGLANZ







COMFORT TOT IN DETAIL

Uittrekbare plateaus en
slimme relingsystemen -
goede ideeën die het
verschil maken.

*CONFORT JUSQUE DANS
LES MOINDRES DÉTAILS*

Tablettes escamotables
et rambardes judicieuses -
ce sont ces bonnes idées
qui font la différence.

KOMFORT

BIS INS DETAIL

**Herausziehbare Tablarböden
und pfiffige Relingsysteme -
es sind gute Ideen, die den
Unterschied machen.**

CONVENIENCE IN EVERY DETAIL

Pull-out shelves and clever
railing systems - it's good ideas
that make the difference.



*FRESH INSPIRATION
FRISSE INSPIRATIE
INSPIRATION FRAÎCHEUR*

FRISCHE INSPIRATION



NISCHENMOTIVE | RECESS MOTIFS
 NISMOTIEVEN | MOTIFS CRÉDENCE



FG 643
Pustoblume
 Dandelion
 Paardenbloem
 Pissenlit



FG 653
Gewürze
 Spices
 Kruiden
 Épices



FG 651
Strand
 Beach
 Strand
 Plage

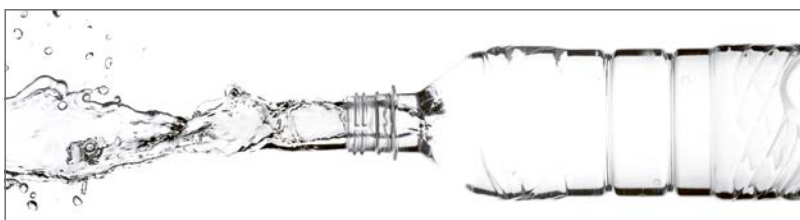

FG 623
Water



FG 626
Fliesenoptik
 Tiled look
 Tegel-look
 Aspect carrelage

FG 647
Antico

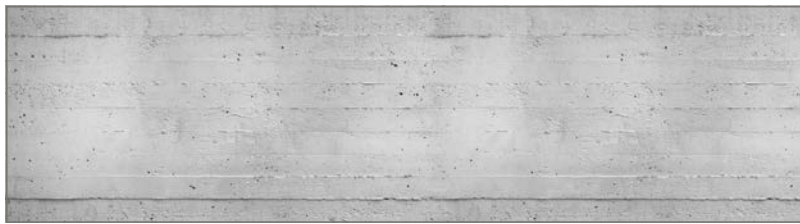

FG 654
Beton
 Concrete
 Beton
 Béton



FG 639
Kräuter
 Herbs
 Kruiden
 Herbes aromatiques



FG 652
Aquarell
 Watercolour
 Aquarel
 Aquarelle



TAFELLACK Blackboard paint Tafellak Gomme-laque

NISCHENMOTIVE
 RECESS MOTIFS
 NISMOTIEVEN
 MOTIFS CRÉDENCE



104 SATINATO

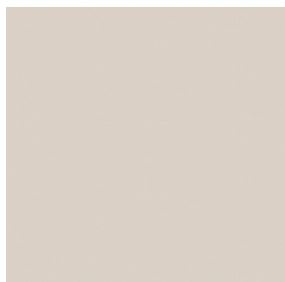

327 SANDBEIGE
 Sand beige
 Zandbeige
 Beige sable

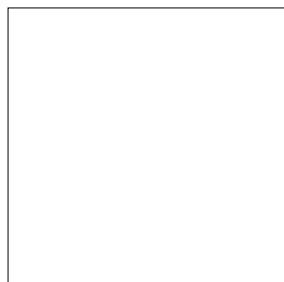

379 WEISS
 White
 Wit
 Blanc

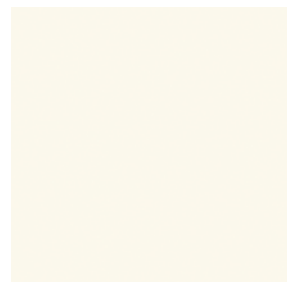

442 SILK



342 SCHWARZ
 Black
 Zwart
 Noir

FG 655

Goldene Linien
Golden Lines
Gouden lijnen
Lignes dorées

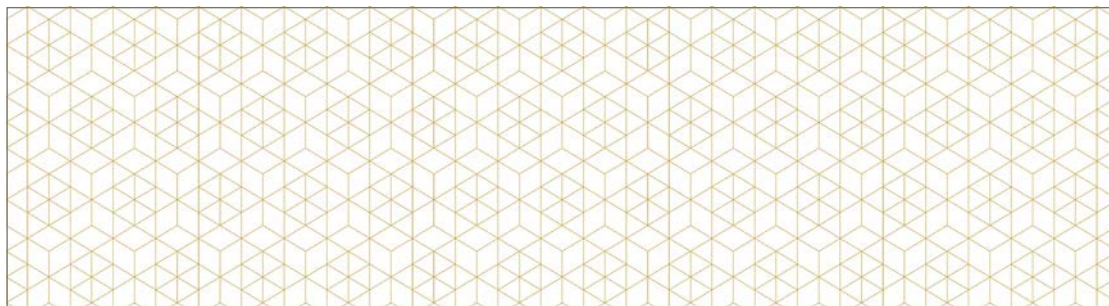

FG 657

Birkenwald
Birch forest
Berkenbos
Forêt de bouleaux



FG 659

Kakteen
Cacti
Cactussen
Cactus



FG 656

Bätter
Leaves
Gebladerte
Feuillage

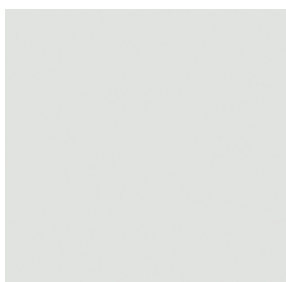

434 MOONLIGHT GREY



FG 658

Palmen
Palm trees
Palmen
Palmiers

FRONTEN | FRONT PANELS | FRONTEN | FAÇADES

PG
1



McAlLEN 155
Kito Stahl
Kito steel
Kito staal
Kito acier

McAlLEN 157
Mocca

McAlLEN 158
Sand
Zand

McAlLEN 159
Terra

PASADENA 147
Black burned

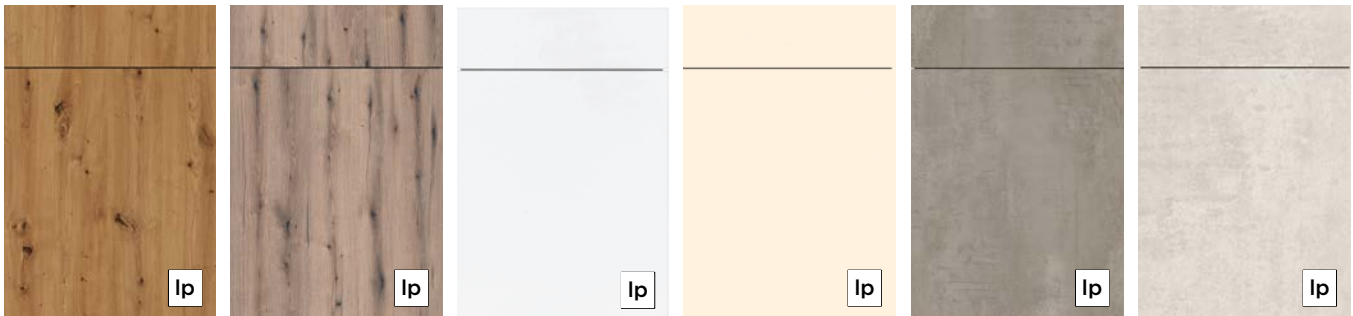

PASADENA 149
Natural Oak

PASADENA 161
Alpine Oak

IDAHO 166
Weiß Perlstruktur
White pearl texture
Wit parelstructuur
Blanc structure perlée

IDAHO 179
Magnolie
Magnolia
Magnolia
Magnolia

KENTUCKY 126
Concrete grey

KENTUCKY 132
Concrete white

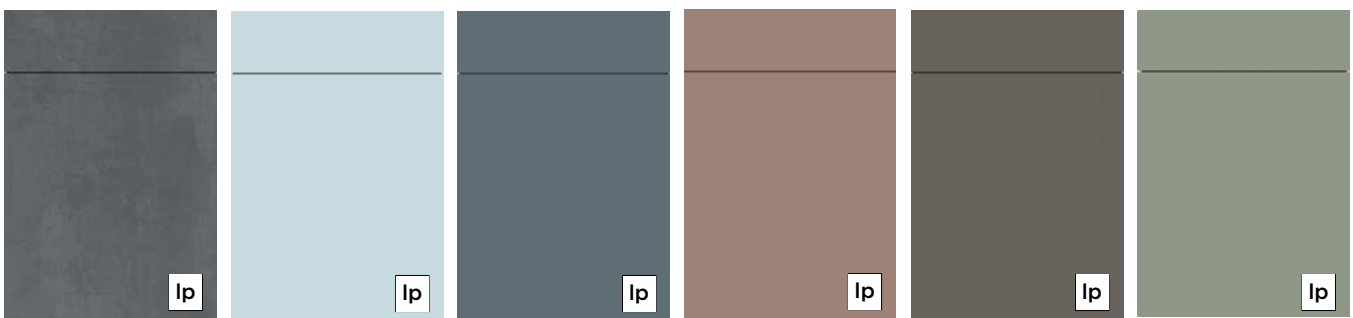

KENTUCKY 134
Concrete anthracite

LOUISIANA 230
Almost blue seidenmatt
Almost blue silky matt
Almost blue zijdemat
Almost blue mat soyeux

LOUISIANA 233
Stormgrey seidenmatt
Stormgrey silky matt
Stormgrey zijdemat
Stormgrey mat soyeux

LOUISIANA 234
Greige
Greige
Greige
Gréige

LOUISIANA 235
Quarzgrau
Quartz grey
Kwartsgrijs
Gris quartz

LOUISIANA 237
Salbei seidenmatt
Sage silky matt
Salie zijdemat
Sauge mat soyeux

lp linea piantra:
Grifflos erhältlich
Available without handles
Greeploos verkrijgbaar
Disponible sans poignées

FRONTEN | FRONT PANELS | FRONTEN | FAÇADES

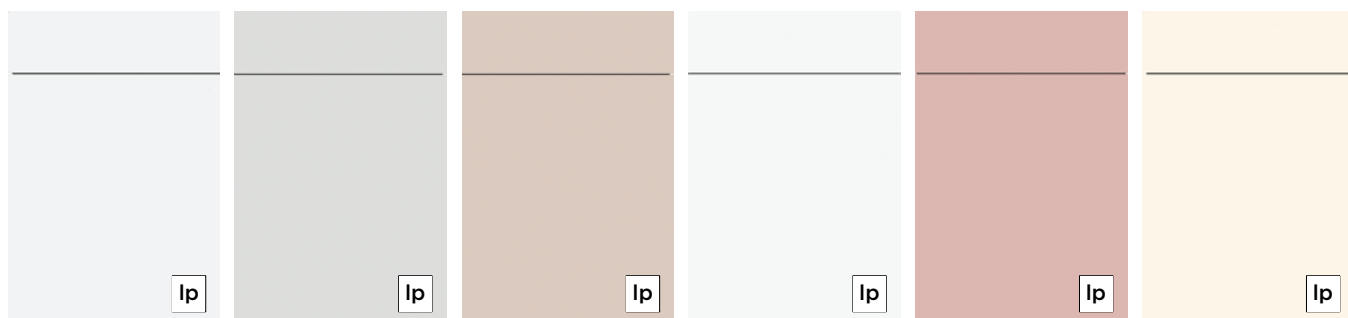

LOUISIANA 239
Weiß seidenmatt
 White silky matt
 Wit zijdemat
 Blanc mat soyeux

LOUISIANA 240
Moonlight grey seidenmatt
 Moonlight grey silky matt
 Moonlight grey zijdemat
 Moonlight grey mat soyeux

LOUISIANA 241
Sandbeige seidenmatt
 Sand beige silky matt
 Zandbeige zijdemat
 Beige sable mat soyeux

LOUISIANA 245
Polarweiß seidenmatt
 Polar white silky matt
 Polarwit zijdemat
 Blanc polaire mat soyeux

LOUISIANA 246
Marshmallow seidenmatt
 Marshmallow silky matt
 Marshmallow zijdemat
 Marshmallow mat soyeux

LOUISIANA 248
Silk seidenmatt
 Silk silky matt
 Silk zijdemat
 Silk mat soyeux

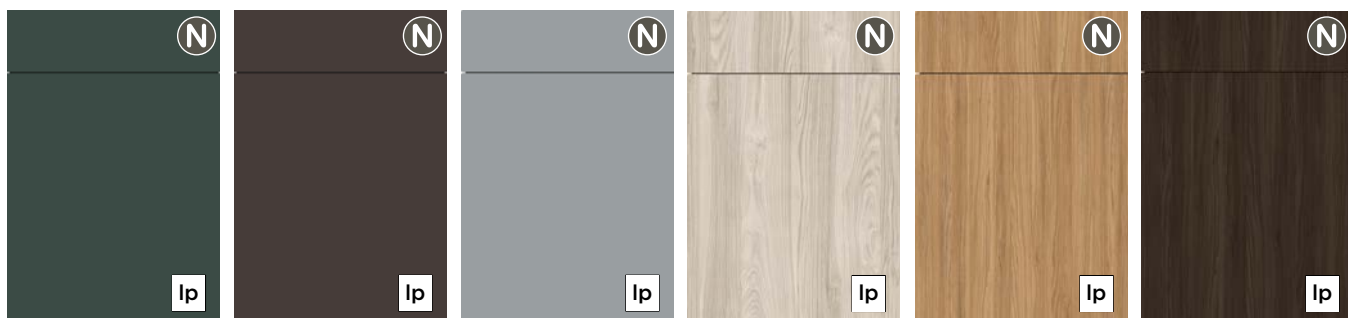

LOUISIANA 252
Black green seidenmatt
 Black green silky matt
 Black green zijdemat
 Black green mat soyeux

LOUISIANA 254
Intense brown seidenmatt
 Intense brown silky matt
 Intense brown zijdemat
 Intense brown mat soyeux

LOUISIANA 255
Nebelgrau seidenmatt
 Mist grey silky matt
 Mist grijs zijdemat
 Gris brume mat soyeux

NEBRASKA 140
Shell Oak

NEBRASKA 141
Honey Oak

NEBRASKA 143
Coffee Oak



NEBRASKA 145
Wild Oak

NEBRASKA 171
Eiche Sand
 Oak sand
 Eiken zand,
 Chêne sable

NEBRASKA 185
Grain hell
 Grain light
 Grain licht
 Grain clair

SALERNO 188
Soft Groove

SALERNO 189
Dark Groove

linea piantra: 
 Grifflos erhältlich
 Available without handles
 Greeploos verkrijgbaar
 Disponible sans poignées

FRONTEN | FRONT PANELS | FRONTEN | FAÇADES

PG
2



HAWAII 201
Black burned



HAWAII 202
Natural Oak



HAWAII 203
Alpine Oak

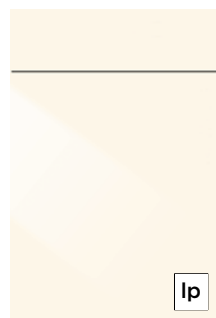

MISSOURI 194
Silk glänzend
Silk gloss
Silk glanzend
Silk brillant

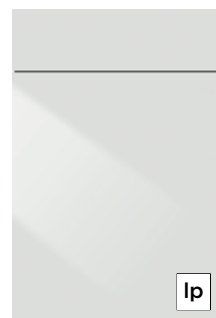

MISSOURI 195
Moonlight grey glänzend
Moonlight grey gloss
Moonlight grey glanzend
Moonlight grey brillant



MISSOURI 200
Weiß glänzend
White gloss
Wit glanzend
Blanc brillant

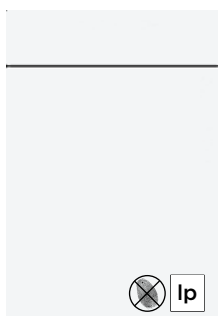

GEORGIA 275
Weiß seidenmatt
White silky matt
Wit zijdemat
Blanc mat soyeux

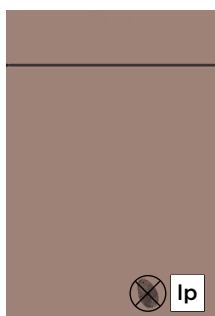

GEORGIA 276
Greige seidenmatt
Greige silky matt
Greige zijdemat
Grège mat soyeux

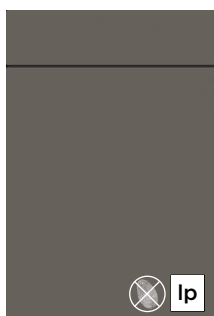

GEORGIA 277
Quarzgrau seidenmatt
Quartz grey silky matt
Kwartsgrijs zijdemat
Gris quartz mat soyeux

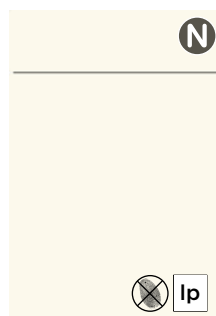

GEORGIA 278
Silk seidenmatt
Silk silky matt
Silk zijdemat
Silk mat soyeux



GEORGIA 279
Schwarz seidenmatt
Black silky matt
Zwart zijdemat
Noir mat soyeux

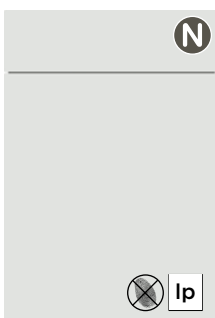

GEORGIA 280
Moonlight grey seidenmatt
Moonlight grey silky matt
Moonlight grey zijdemat
Moonlight grey mat soyeux

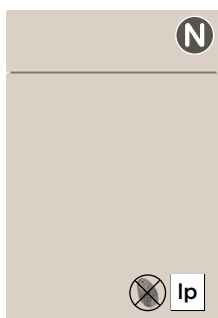

GEORGIA 281
Sandbeige seidenmatt
Sand beige silky matt
Zandbeige zijdemat
Beige sable mat soyeux

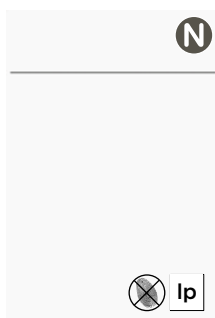

GEORGIA 282
Polarweiß seidenmatt
Polar white silky matt
Polarwit zijdemat
Blanc polaire mat soyeux

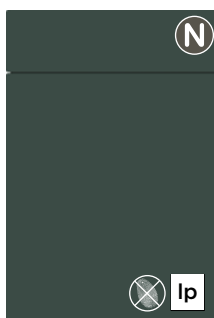

GEORGIA 286
Black green seidenmatt
Black green silky matt
Black green zijdemat
Black green mat soyeux

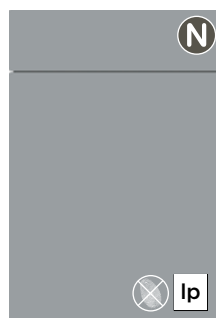

GEORGIA 287
Nebelgrau seidenmatt
Mist grey silky matt
Mist grijs zijdemat
Gris brume mat soyeux

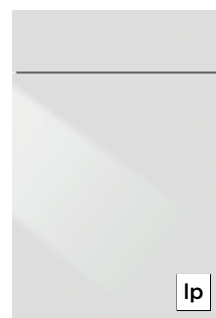

NEW MEXICO 265
Moonlight grey Hochglanz
Moonlight grey high-gloss
Moonlight grey hoogglans
Moonlight grey brillant

lp linea piantra:
Grifflos erhältlich
Available without handles
Greeploos verkrijgbaar
Disponible sans poignées

Anti-Fingerprint
Anti-fingerprint
Anti-fingerprint
Anti-traces de doigts

FRONTEN | FRONT PANELS | FRONTEN | FAÇADES

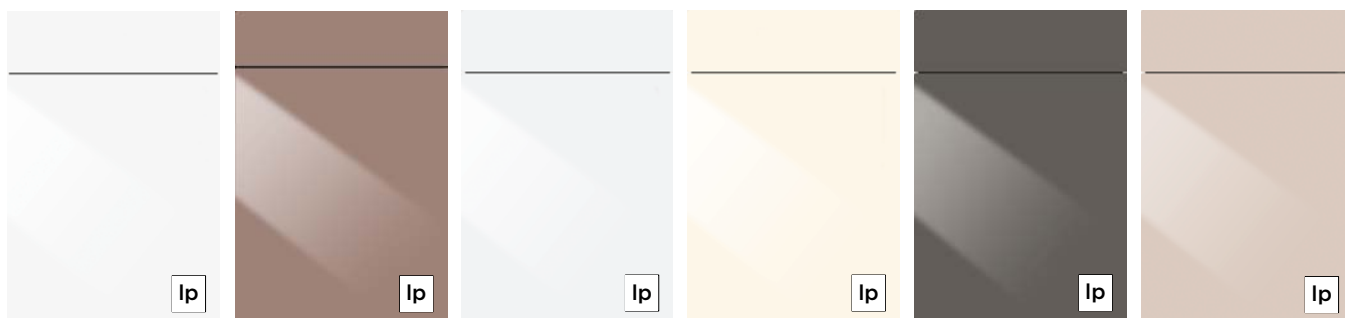

NEW MEXICO 268

Polarweiß Hochglanz
Polar white high-gloss
Polarwit hoogglaans
Blanc polaire brillant

NEW MEXICO 294

Greige Hochglanz
Greige high-gloss
Greige hoogglaans
Grège brillant

NEW MEXICO 296

Weiß Hochglanz
White high-gloss
Wit hoogglaans
Blanc brillant

NEW MEXICO 297

Silk Hochglanz
Silk high-gloss
Silk hoogglaans
Silk brillant

NEW MEXICO 298

Quarzgrau Hochglanz
Quartz grey high-gloss
Kwartsgrijs hoogglaans
Gris quartz brillant

NEW MEXICO 299

Sandbeige Hochglanz
Sand beige high-gloss
Zandbeige hoogglaans
Beige sable brillant

PG
3

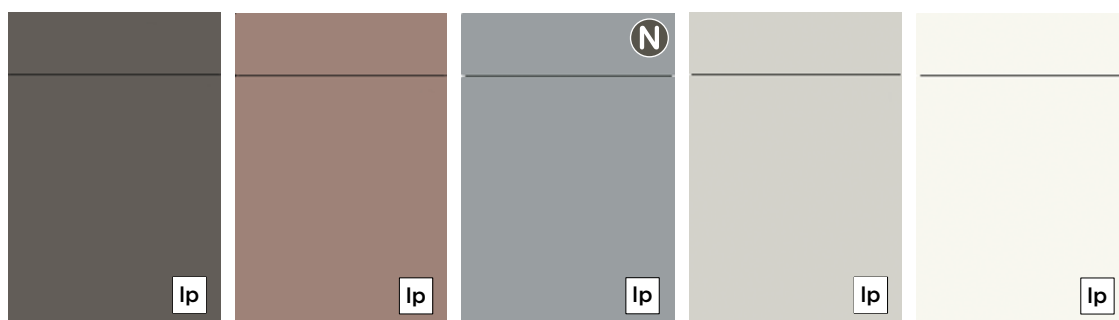

PENNSYLVANIA 356

Quarzgrau seidenmatt
Quartz grey silky matt
Kwartsgrijs zijdemat
Gris quartz mat soyeux

PENNSYLVANIA 357

Greige seidenmatt
Greige silky matt
Greige zijdemat
Grège mat soyeux

PENNSYLVANIA 358

Nebelgrau seidenmatt
Mist grey silky matt
Mist grijs zijdemat
Gris brume mat soyeux

PENNSYLVANIA 389

Moonlight grey seidenmatt
Moonlight grey silky matt
Moonlight grey zijdemat
Moonlight grey mat soyeux

PENNSYLVANIA 391

Weiß seidenmatt
White silky matt
Wit zijdemat
Blanc mat soyeux

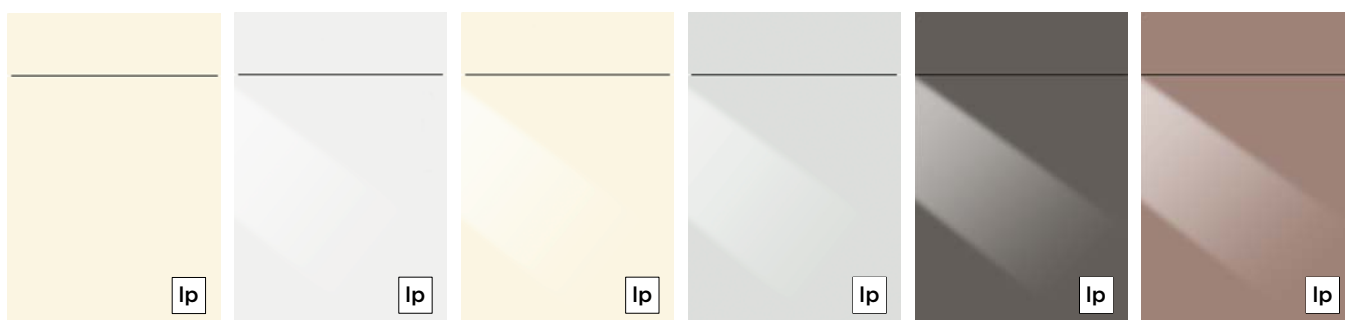

PENNSYLVANIA 392

Silk seidenmatt
Silk silky matt
Silk zijdemat
Silk mat soyeux

PORTLAND 380

Weiß Hochglanz
White high-gloss
Wit hoogglaans
Blanc brillant

PORTLAND 383

Silk Hochglanz
Silk high-gloss
Silk hoogglaans
Silk brillant

PORTLAND 384

Moonlight grey Hochglanz
Moonlight grey high-gloss
Moonlight grey hoogglaans
Moonlight grey brillant

PORTLAND 385

Quarzgrau Hochglanz
Quartz grey high-gloss
Kwartsgrijs hoogglaans
Gris quartz brillant

PORTLAND 387

Greige Hochglanz
Greige high-gloss
Greige hoogglaans
Grège brillant

linea piantra: 
Grifflos erhältlich
Available without handles
Greploos verkrijgbaar
Disponibile sans poignées

FRONTEN | FRONT PANELS | FRONTEN | FAÇADES



IOWA 435
Sandbeige seidenmatt
 Sand beige silky matt
 Zandbeige zijdemat
 Beige sable mat soyeux



IOWA 436
Moonlight grey seidenmatt
 Moonlight grey silky matt
 Moonlight grey zijdemat
 Moonlight grey mat soyeux



IOWA 437
Salbei seidenmatt
 Sage silky matt
 Salie zijdemat
 Sauge mat soyeux



IOWA 438
Silk seidenmatt
 Silk silky matt
 Silk zijdemat
 Silk mat soyeux



IOWA 439
Weiß seidenmatt
 White silky matt
 Wit zijdemat
 Blanc mat soyeux



IOWA 446
Quarzgrau seidenmatt
 Quartz grey silky matt
 Kwartzgrijs zijdemat
 Gris quartz mat soyeux



IOWA 448
Schwarz seidenmatt
 Black silky matt
 Zwart zijdemat
 Noir mat soyeux



IOWA 449
Greige seidenmatt
 Greige silky matt
 Greige zijdemat
 Grège mat soyeux

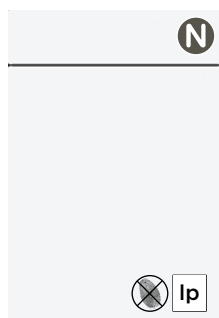

JERSEY 331
Weiß seidenmatt
 White silky matt
 Wit zijdemat
 Blanc mat soyeux

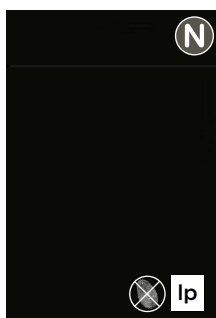

JERSEY 332
Schwarz seidenmatt
 Black silky matt
 Zwart zijdemat
 Noir mat soyeux



KANSAS 370
Weiß seidenmatt
 White silky matt
 Wit zijdemat
 Blanc mat soyeux



KANSAS 371
Quarzgrau seidenmatt
 Quartz grey silky matt
 Kwartzgrijs zijdemat
 Gris quartz mat soyeux



KANSAS 372
Silk seidenmatt
 Silk silky matt
 Silk zijdemat
 Silk mat soyeux



KANSAS 373
Greige seidenmatt
 Greige silky matt
 Greige zijdemat
 Grège mat soyeux



KANSAS 374
Nebelgrau seidenmatt
 Mist grey silky matt
 Mist grijs zijdemat
 Gris brume mat soyeux

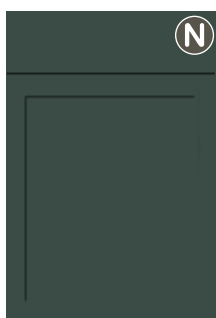

KANSAS 375
Black green seidenmatt
 Black green silky matt
 Black green zijdemat
 Black green mat soyeux

PG
5



TENNESSEE 351
Weiß Hochglanz
 White high-gloss
 Wit hoogglans
 Blanc brillant

Ip **linea piantra:**
 Grifflos erhältlich
 Available without handles
 Greeploos verkrijgbaar
 Disponible sans poignées

Anti-Fingerprint
 Anti-fingerprint
 Anti-fingerprint
 Anti-traces de doigts





106 Magnolie
106 Magnolia
106 Magnolia
106 Magnolia



107 Eiche Sand
107 Oak sand
107 Eiken zand
107 Chêne sable



116 Weiß
116 White
116 Wit
116 Blanc



119 Grain hell
119 Grain light
119 Grain licht
119 Grain clair



124 Wild Oak

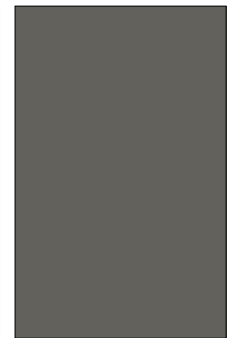

126 Quarzgrau
126 Quartz grey
126 Kwartsgrijs
126 Gris quartz

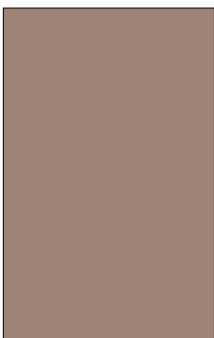

127 Greige



131 Natural Oak

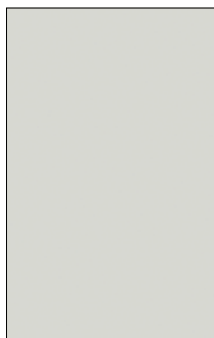

142 Moonlight grey seidenmatt
142 Moonlight grey silky matt
142 Moonlight grey zijdemat
142 Moonlight grey mat soyeux



143 Sandbeige seidenmatt
143 Sand beige silky matt
143 Zandbeige zijdemat
143 Beige sable mat soyeux

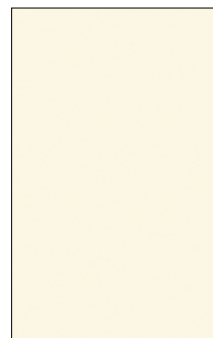

146 Silk seidenmatt
146 Silk silky matt
146 Silk zijdemat
146 Silk mat soyeux

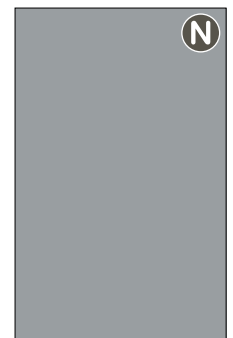

125 Nebelgrau seidenmatt
125 Mist grey silky matt
125 Mist grijs zijdemat
125 Gris brume mat soyeux

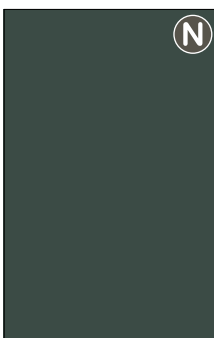

118 Black green seidenmatt
118 Black green silky matt
118 Black green zijdemat
118 Black green mat soyeux



134 Shell Oak



135 Honey Oak



136 Coffe Oak



115 Schwarz
115 Black
115 Zwart
115 Noir

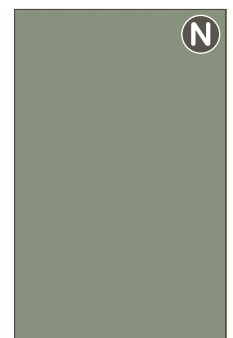

114 Salbei seidenmatt
114 Sage silky matt
114 Salie zijdemat
114 Sauge mat soyeux



145 Polarweiß seidenmatt
 145 Polar white silky matt
 145 Polarwit zijdemat
 145 Blanc polaire mat
 soyeux

113 Weiß seidenmatt
 113 White silky matt
 113 Wit zijdemat
 113 Blanc mat soyeux

SICHTSEITEN | VISIBLE SIDES | ZICHTBARE ZIJDEN | CÔTÉS VISIBLES



588 Concrete grey

589 Concrete white

596 Concrete anthracite

177 Weiß glänzend
 177 White gloss
 177 Wit glanzend
 177 Blanc brillant

727 Sandbeige glänzend
 727 Sand beige gloss
 727 Zandbeige glanzend
 727 Beige sable brillant

728 Moonlight grey glänzend
 728 Moonlight grey gloss
 728 Moonlight grey glanzend
 728 Moonlight grey brillant

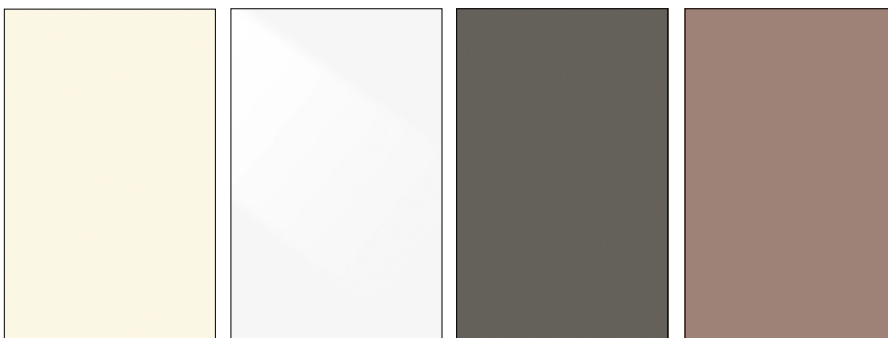

729 Silk glänzend
 729 Silk gloss
 729 Silk glanzend
 729 Silk brillant

735 Polarweiß glänzend
 735 Polar white gloss
 735 Polarwit glanzend
 735 Blanc polaire brillant

738 Quarzgrau glänzend
 738 Quartz grey gloss
 738 Kwartzgrijs glanzend
 738 Gris quartz brillant

742 Greige glänzend
 742 Greige white
 742 Greige glanzend
 742 Grège brillant

ARBEITSPLATTEN 16, 25 UND 39 MM | WORKTOPS 16, 25 AND 39 MM
 WERKBLADEN 16, 25 EN 39 MM | PLANS DE TRAVAIL 16, 25 ET 39 MM



865 Ceramica



869 Eiche Sand
 869 Oak sand
 869 Eiken zand
 869 Chêne sable



882 Grain hell
 882 Grain light
 882 Grain licht
 882 Grain clair



883 Rock Kiesel
 883 Rock pebble
 883 Rock kiezel
 883 Rock gravier



889 Concrete grey



890 Concrete white



891 Grain Cognac



893 Arizona Pine



898 Concrete anthracite



937 Historic Oak



941 Black burned



942 Natural Oak



947 Atlantic Stone Steel



952 Ulme gekälkt
 952 Elm limed
 952 Olm gekalkt
 952 Orme blanchi



953 Alpine Oak



956 Elegant brown



957 Saloon



960 Kito Stahl
 960 Kito steel
 960 Kito staal
 960 Kito acier

ARBEITSPLATTEN 16, 25 UND 39 MM | WORKTOPS 16, 25 AND 39 MM
WERKBLADEN 16, 25 EN 39 MM | PLANS DE TRAVAIL 16, 25 ET 39 MM

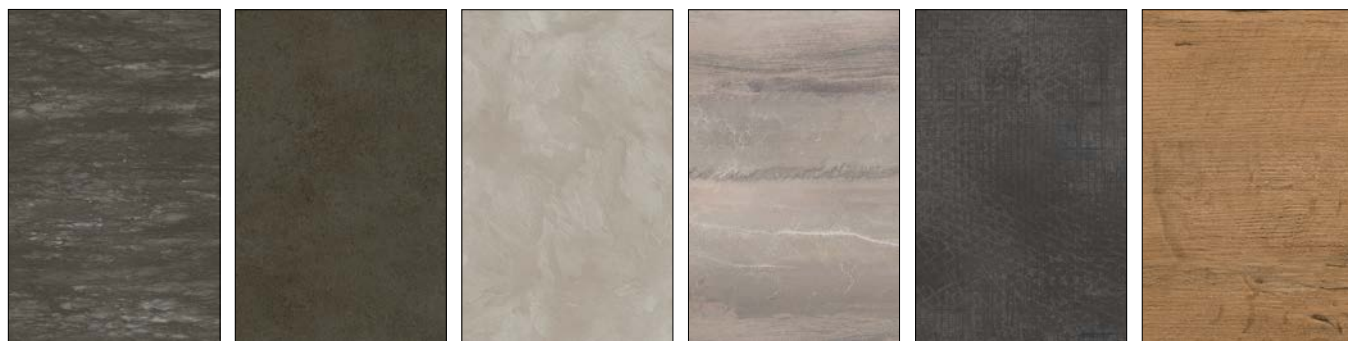

961 Skyfall

962 Mocca

964 Tibet

965 Quarz Rose

966 Stone Grid

967 Wild Oak



969 Marmor Grigio

970 Marmor Bianco

971 Moon

973 Terra

976 Green Slade

978 Marmor Nero



979 Sand
979 Zand

980 Shell Oak

981 Honey Oak

982 Coffee Oak

983 Amber Oak

PULT- & THEKENPLATTEN 90 MM | BAR AND COUNTER TOPS 90 MM
 DIKKE WERKBLADEN & BARBLADEN 90 MM
 PLANS DE TRAVAIL ÉPAIS ET COMPTOIRS 90 MM



882 Grain hell
 882 Grain light
 882 Grain licht
 882 Grain clair

889 Concrete grey

891 Grain Cognac

893 Arizona Pine

898 Concrete anthracite

937 Historic Oak



941 Black burned

942 Natural Oak

953 Alpine Oak

956 Elegant brown

957 Saloon

961 Skyfall



967 Wild Oak

969 Marmor Grigio

970 Marmor Bianco

973 Terra

978 Marmor Nero

979 Sand
 979 Zand

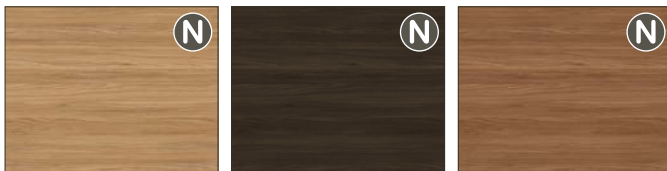

981 Honey Oak

982 Coffee Oak

983 Amber Oak

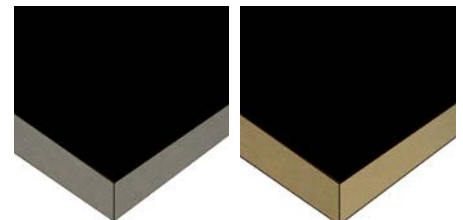

Kante
 edge
 kant
 chant

Kante
 edge
 kant
 chant

FG 154 Edelhoptik
 FG 154 Stainless-steel look
 FG 154 roestvrij staal-look
 FG 154 Aspect inox

FG 155 Messingoptik
 FG 155 Brass look
 FG 155 messing-look
 FG 155 Aspect laiton

GRIFFLEISTEN LINEA PIANTRA | LINEA PIANTRA FINGER PULLS
 GREEPLIJSTEN LINEA PIANTRA | POIGNÉES PROFIL LINEA PIANTRA



FG 399
Edelstahlfarbig
 Stainless steel coloured
 Rvs-kleur
 Couleur inox

FG 420
Weiß gepulvert
 White, powder-coated
 wit poedercoating
 Blanc, poudre époxy

FG 421
Moonlight grey gepulvert
 Moonlight grey, powder-coated
 Moonlight grey poedercoating
 Moonlight grey, poudre époxy

FG 422
Quarzgrau gepulvert
 Quartz grey, powder-coated
 kwartsgrijs poedercoating
 Gris quartz, poudre époxy

FG 424
Polarweiß gepulvert
 Polar white, powder-coated
 poolwit poedercoating
 Blanc polaire, poudre époxy

FG 456
Schwarz gepulvert
 Black, powder-coated
 zwart poedercoating
 Noir, poudre époxy

GRIFFE | HANDLES | GREPEN | POIGNÉES



Nr. 118

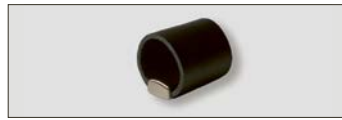

Nr. 316



Nr. 606



Nr. 121



Nr. 401



Nr. 613



Nr. 122



Nr. 511



Nr. 646



Nr. 123



Nr. 512



Nr. 666



Nr. 124



Nr. 513



Nr. 673



Nr. 125



Nr. 514



Nr. 677



Nr. 126



Nr. 515



Nr. 702



Nr. 127



Nr. 602

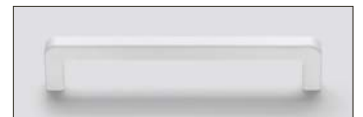

Nr. 706



Nr. 128



Nr. 603



Nr. 715

GRIFFE | HANDLES | GREPEN | POIGNÉES

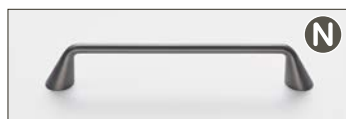

Nr. 716



Nr. 736



Nr. 754



Nr. 720



Nr. 737



Nr. 755



Nr. 721



Nr. 738



Nr. 761



Nr. 722



Nr. 739



Nr. 769



Nr. 723



Nr. 741

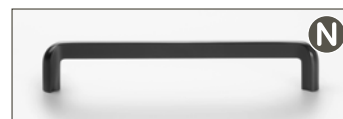

Nr. 786



Nr. 724



Nr. 743



Nr. 787



Nr. 725



Nr. 745



Nr. 788

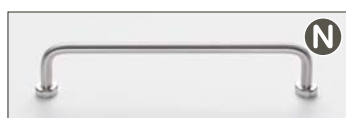

Nr. 728



Nr. 751

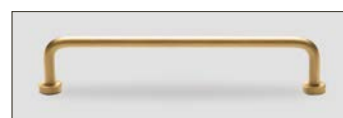

Nr. 790



Nr. 731



Nr. 752



Nr. 791



Nr. 796



Nr. 224



Nr. 228



Nr. 802



Nr. 225



Nr. 276



Nr. 202



Nr. 226



Nr. 230



Nr. 222



Nr. 227



Nr. 250



Nr. 242



Nr. 253



Nr. 278



Nr. 243



Nr. 254



Nr. 298



Nr. 252



Nr. 255

prisma multi | KÜCHENWELTEN

prisma®

meine Küche!

MACHEN SIE IHRE KÜCHE ZUM SCHÖNSTEN ORT DER WELT. Ihr prisma-Händler in Ihrer Nähe steht Ihnen mit Rat und Tat sowie den schönsten Küchenmodellen zur Seite.

prisma | Küchenwelten | www.prisma-kuechen.de

Änderungen im Programm, Material, Ausführung, Abmessungen bleiben vorbehalten.
Alle Einrichtungsbeispiele sind unverbindlich. Druckfehlerberichtigungen behalten wir uns vor.
Mit Erscheinen dieses Katalogs verlieren alle bisherigen ihre Gültigkeit.